

**WINPOD**

BY WINTECH

REDIFINE YOUR WORKING SPACE



**WINPOD (THAILAND) CO.LTD**

30/2, Soi Prachachuen 27, Prachachuen Road, Bangkok 10800.

[www.winpod.co.th](http://www.winpod.co.th)

# winpod

BY WINTECH®

[www.winpod.co.th](http://www.winpod.co.th)

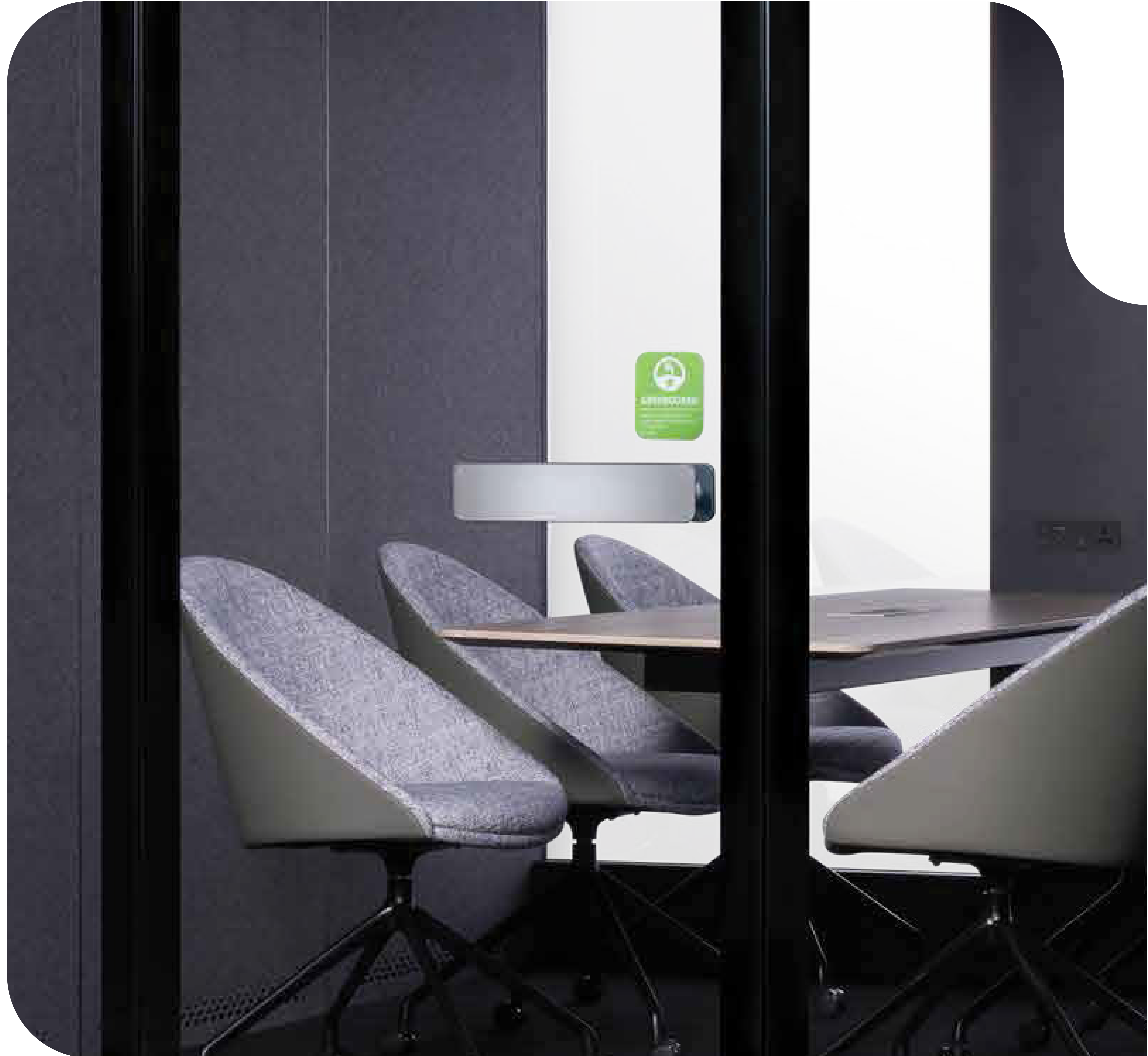

# About Us



We believe that a great environment nurtures great talents. This is why each and every one of our steel products is designed to optimise space and improve the work environment. Our state-of-the-art technology as well as continuous research and development efforts, fuels our constant success as the leading manufacturer of metal-fabricated furnishing.

Wir glauben, dass eine großartige Umgebung großartige Talente fördert. Deshalb sind alle unsere Stahlprodukte so gestaltet, dass sie den Raum optimieren und das Arbeitsumfeld verbessern. Unsere hochmoderne Technologie sowie kontinuierliche Forschungs- und Entwicklungsbemühungen treiben unseren ständigen Erfolg als führender Hersteller von metallgefertigten Möbeln voran.



SCAN HERE



Bridging Distances, Connecting Worlds

[www.winpod.co.th](http://www.winpod.co.th)

## ALL RIGHTS RESERVED BY:

<b>MALAYSIA</b>	<b>: 24-00357-0101</b>	<b>CHINA</b>	<b>: 24W0018MY</b>
<b>USA</b>	<b>: 29/930.206</b>	<b>UK</b>	<b>: 6349613</b>
<b>EUROPE</b>	<b>: 015052152</b>	<b>AUSTRALIA</b>	<b>: 202411268</b>
<b>SINGAPORE</b>	<b>: 30202400292T</b>	<b>NEW ZEALAND</b>	<b>: 433372</b>
<b>THAILAND</b>	<b>: 2402000922</b>	<b>PHILIPPINES</b>	<b>: 3-2024-050184</b>
<b>INDONESIA</b>	<b>: A002024 00842</b>	<b>INDIA</b>	<b>: 408950-001</b>

**winpod**  
BY WINTECH<sup>®</sup>

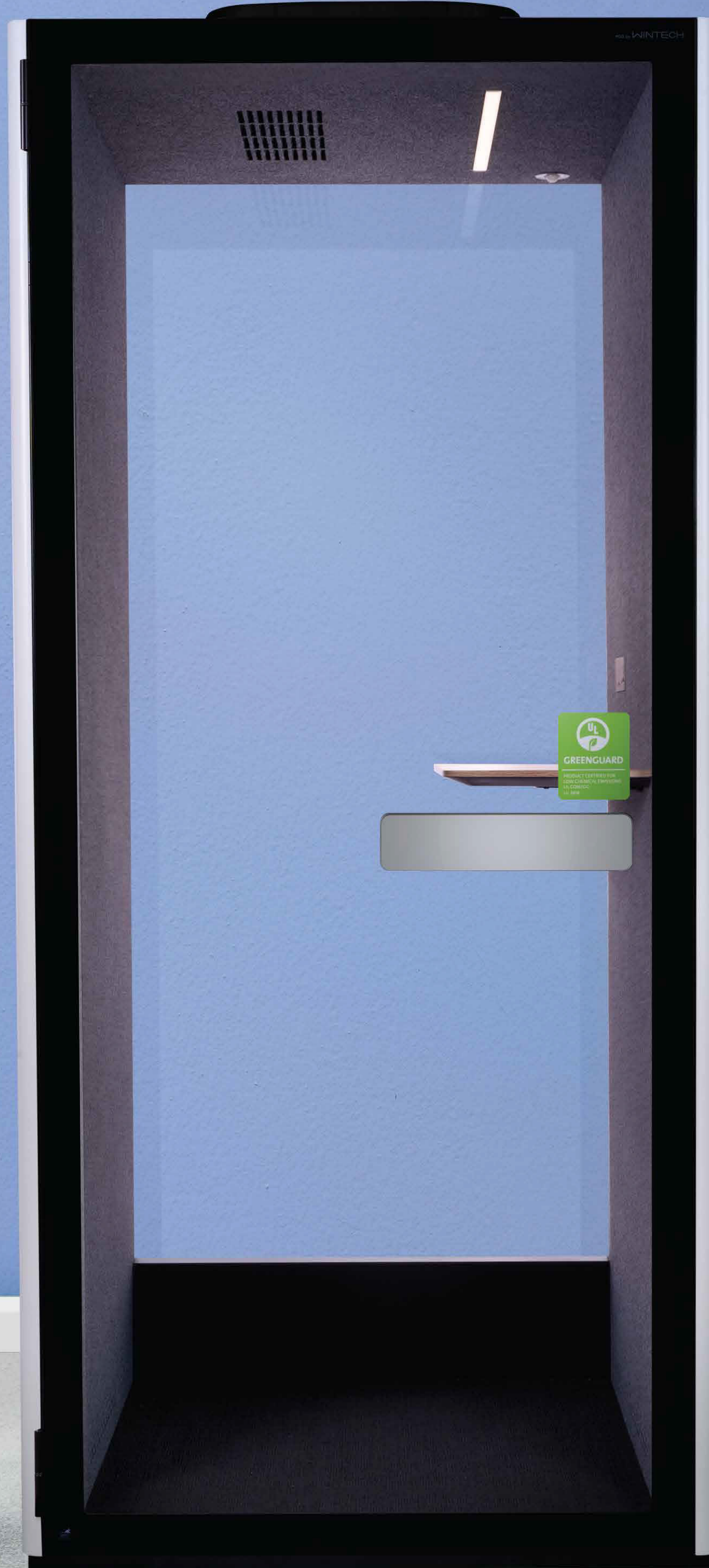

[www.winpod.co.th](http://www.winpod.co.th)

# S POD 3.0

## PLUS SERIES

S POD 3.0 is a classic pod for single person. In the serene space, an individual can carry out works that requires high level of privacy such as signing contracts, making phone calls, and video conference.

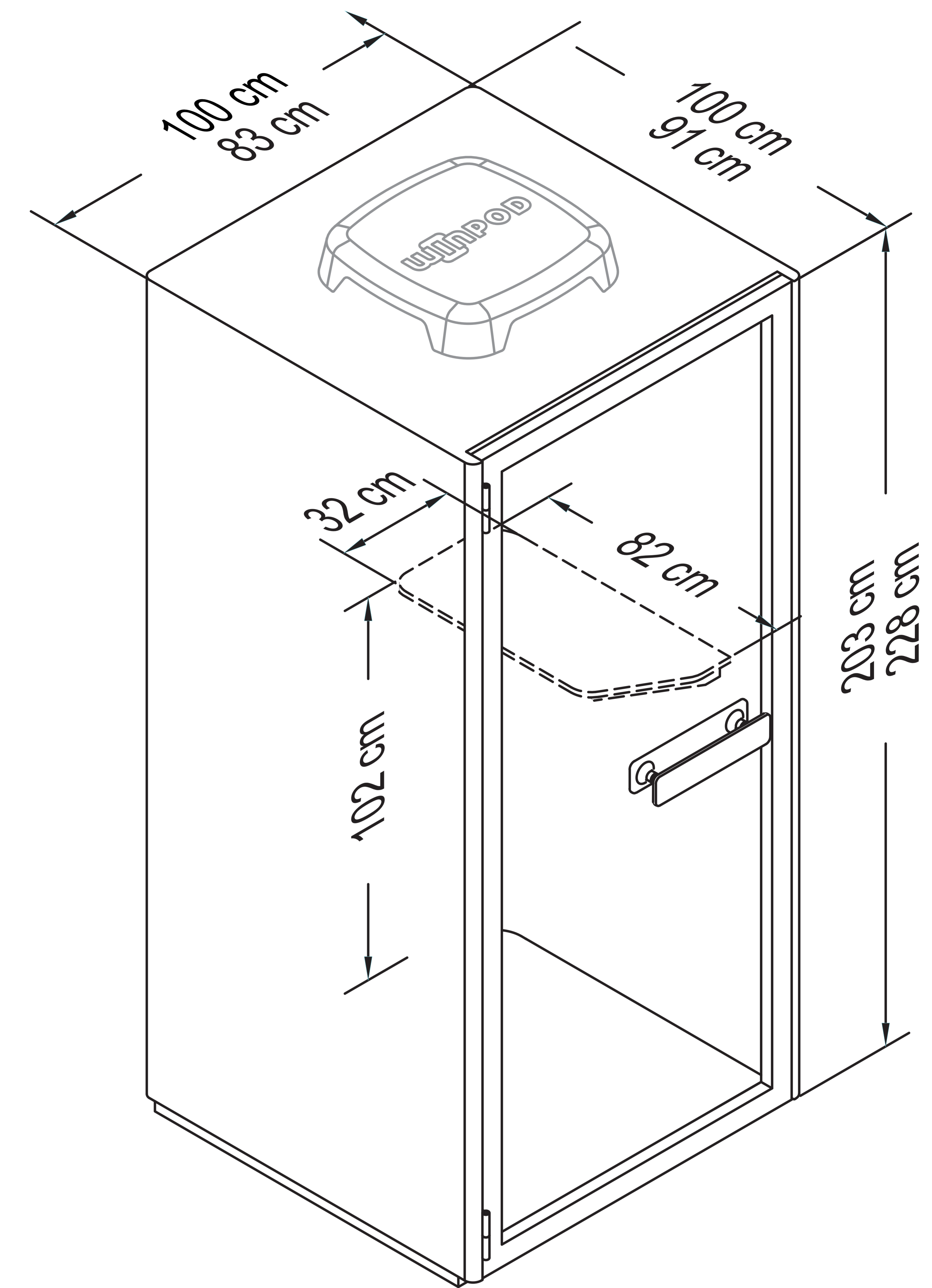

### Application

Commercial Office, Premium residence, Airport Lounge, Waiting Area, Library Space, Hotel Lobby & Reception, Institutions, Showroom

### UNIQUE FEATURES

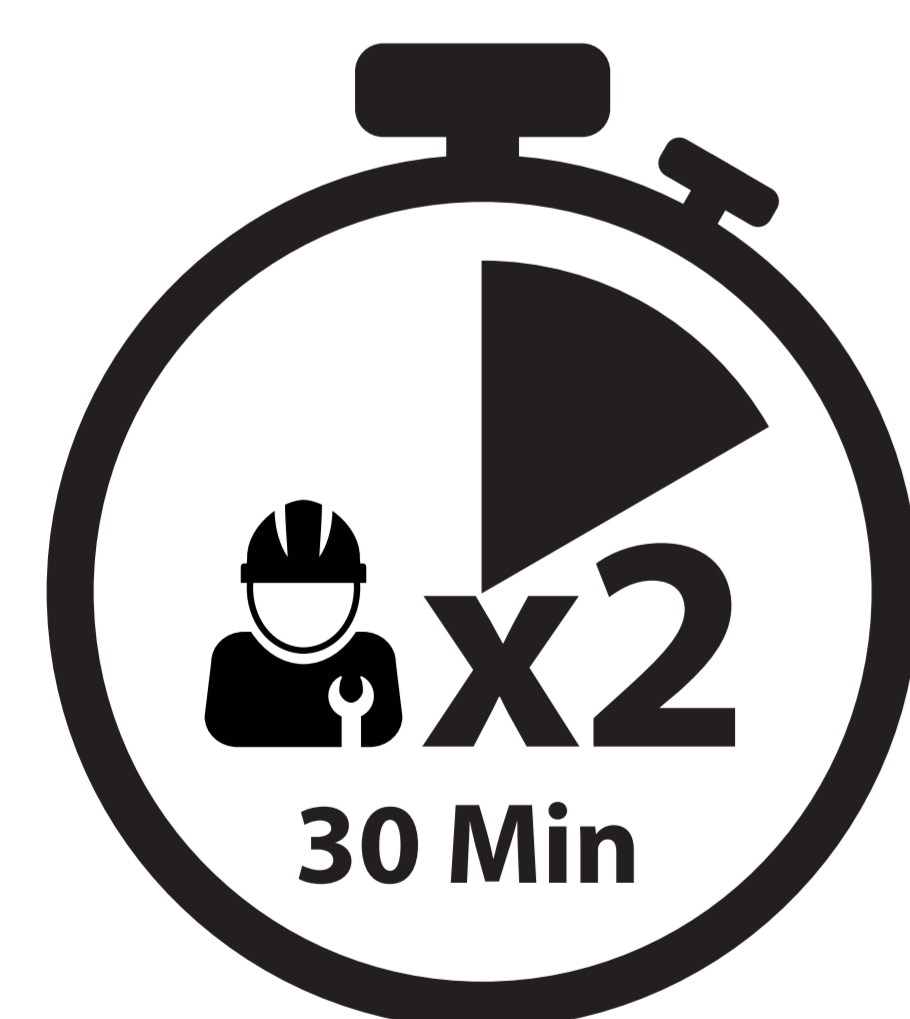

Quick & Easy  
Assembly



Height Adjustable  
Table (\*Optional)



High Acoustic Rating  
Tested by TÜV SÜD  
(ISO 23351-1 Standard)

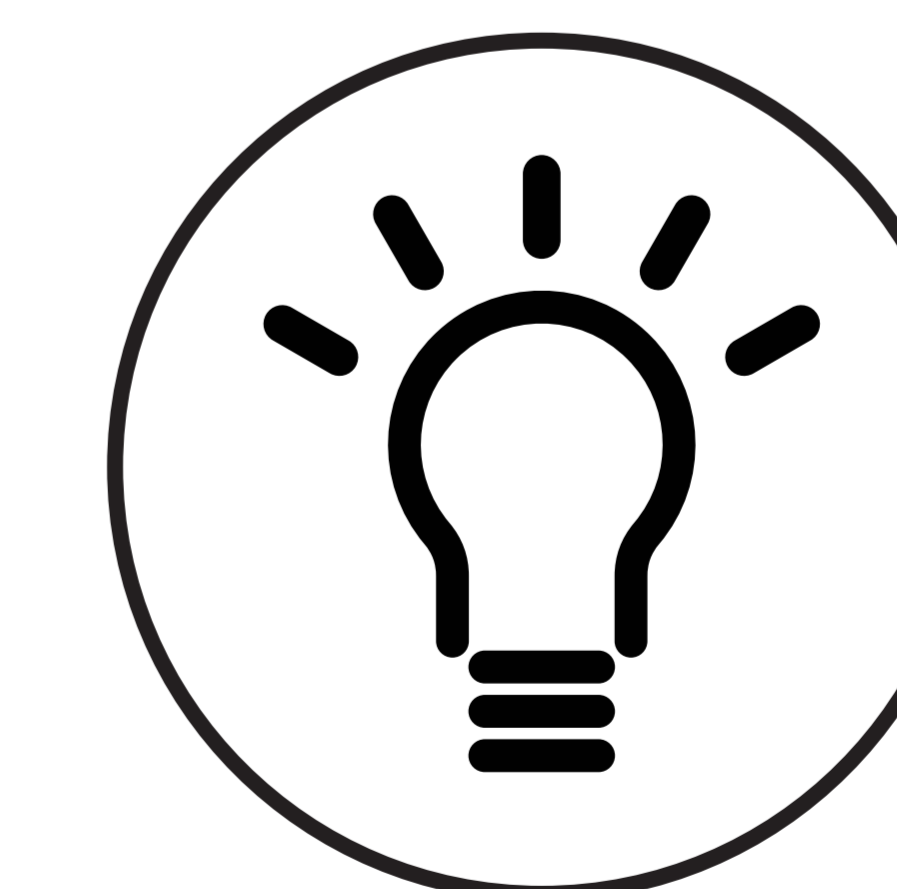

Occupancy Indicator  
Light

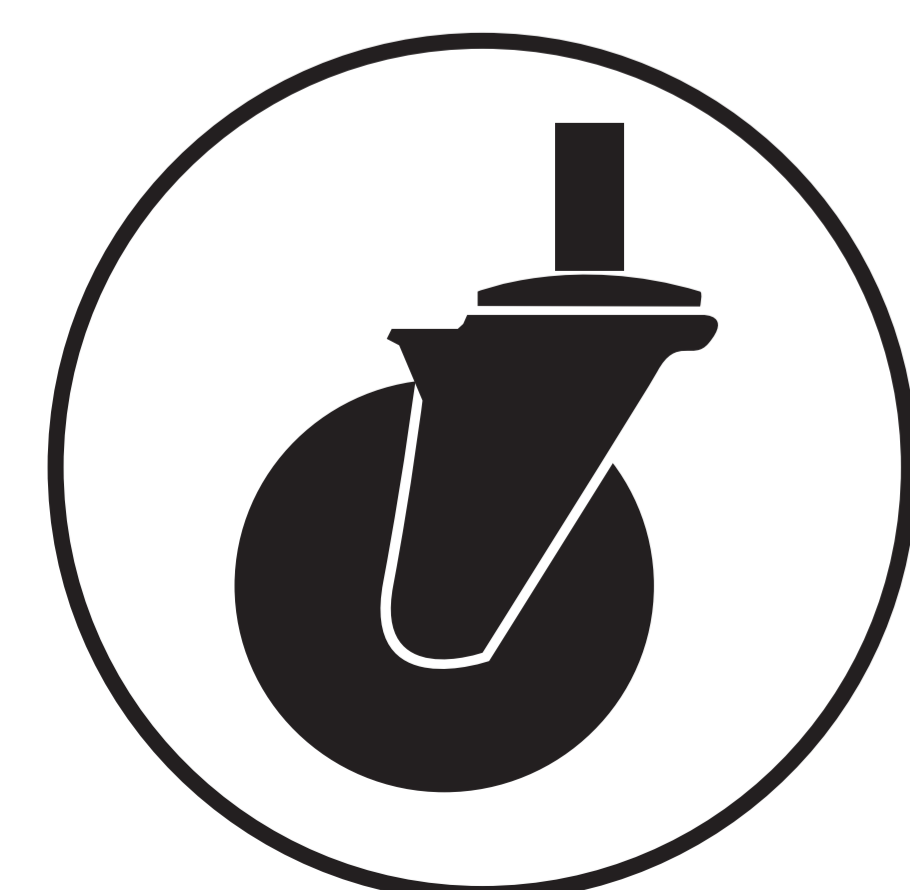

Build In with  
Heavy Duty Castor

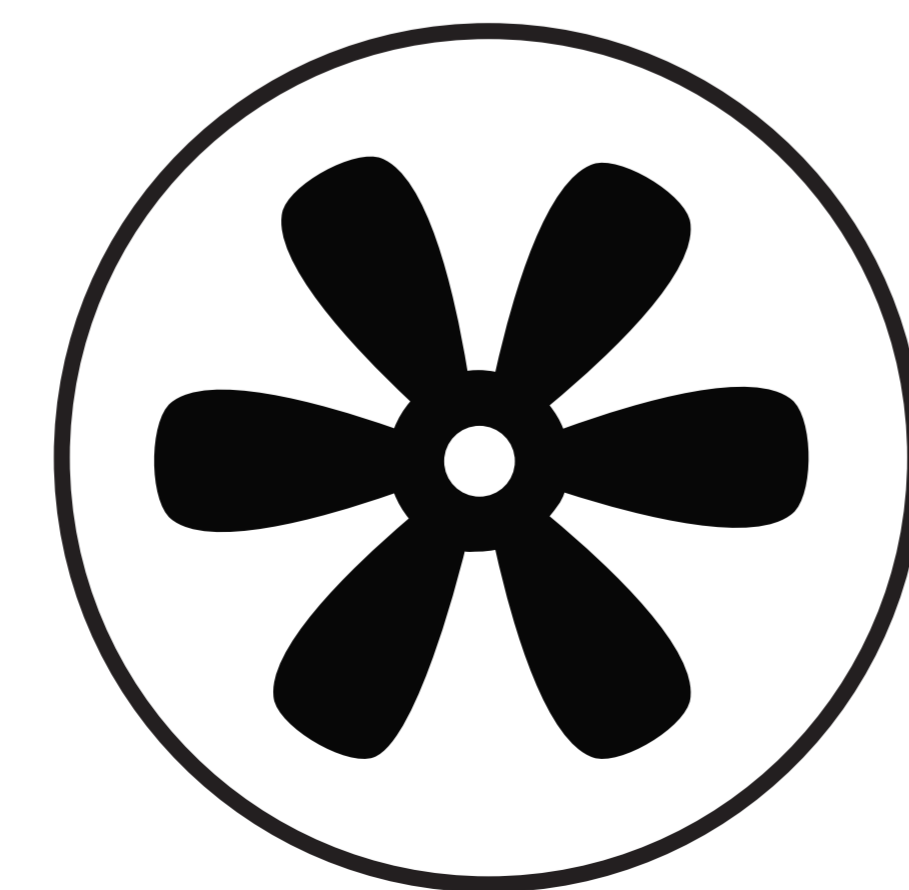

Smart Ventilation  
System with Pre Filter



Integrated Touch  
Panel System

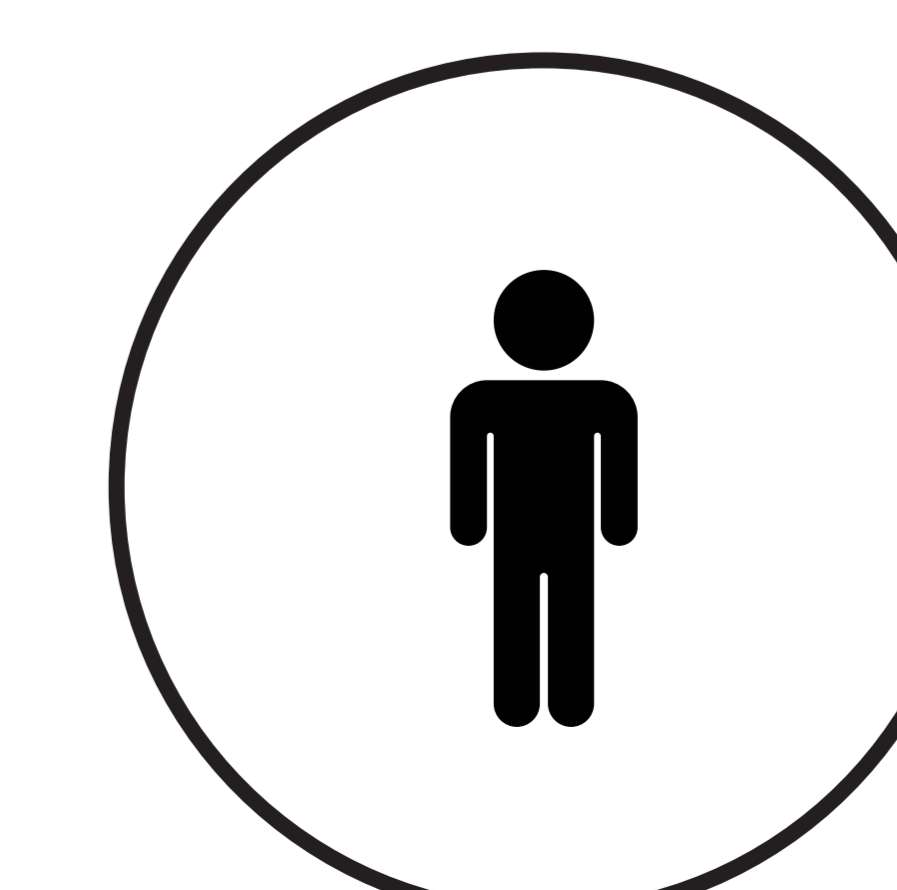

Occupancy up to 1 Pax

**winpod**  
BY WINTECH®

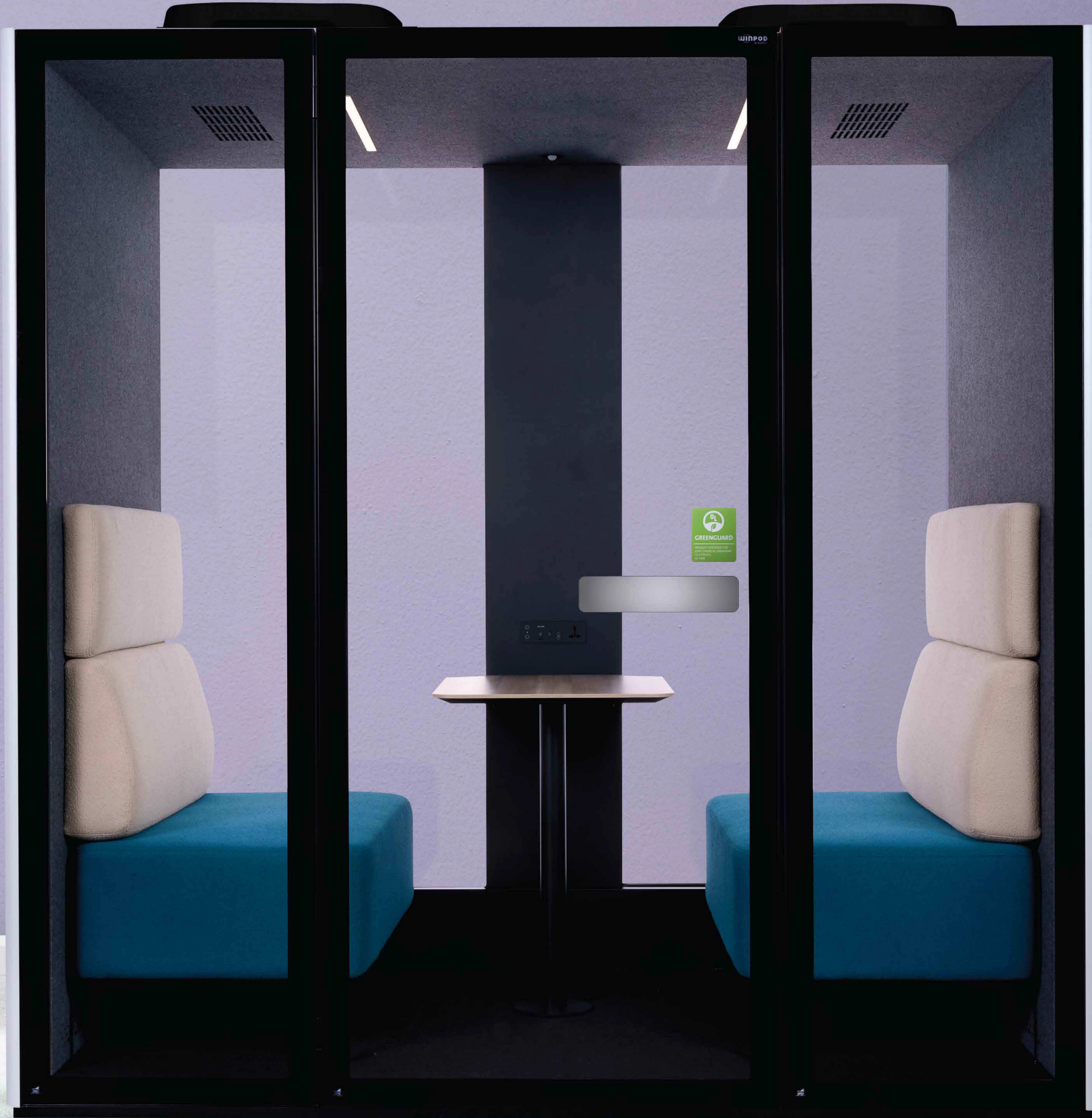

[www.winpod.co.th](http://www.winpod.co.th)

# D POD 3.0

## PLUS SERIES

D POD 3.0 can accommodate two to four persons. The sofas come with comfortable backrest allow users to carry out discussions in a relaxed manner, most importantly free disturbance. Aiming to achieve satisfaction and better results.

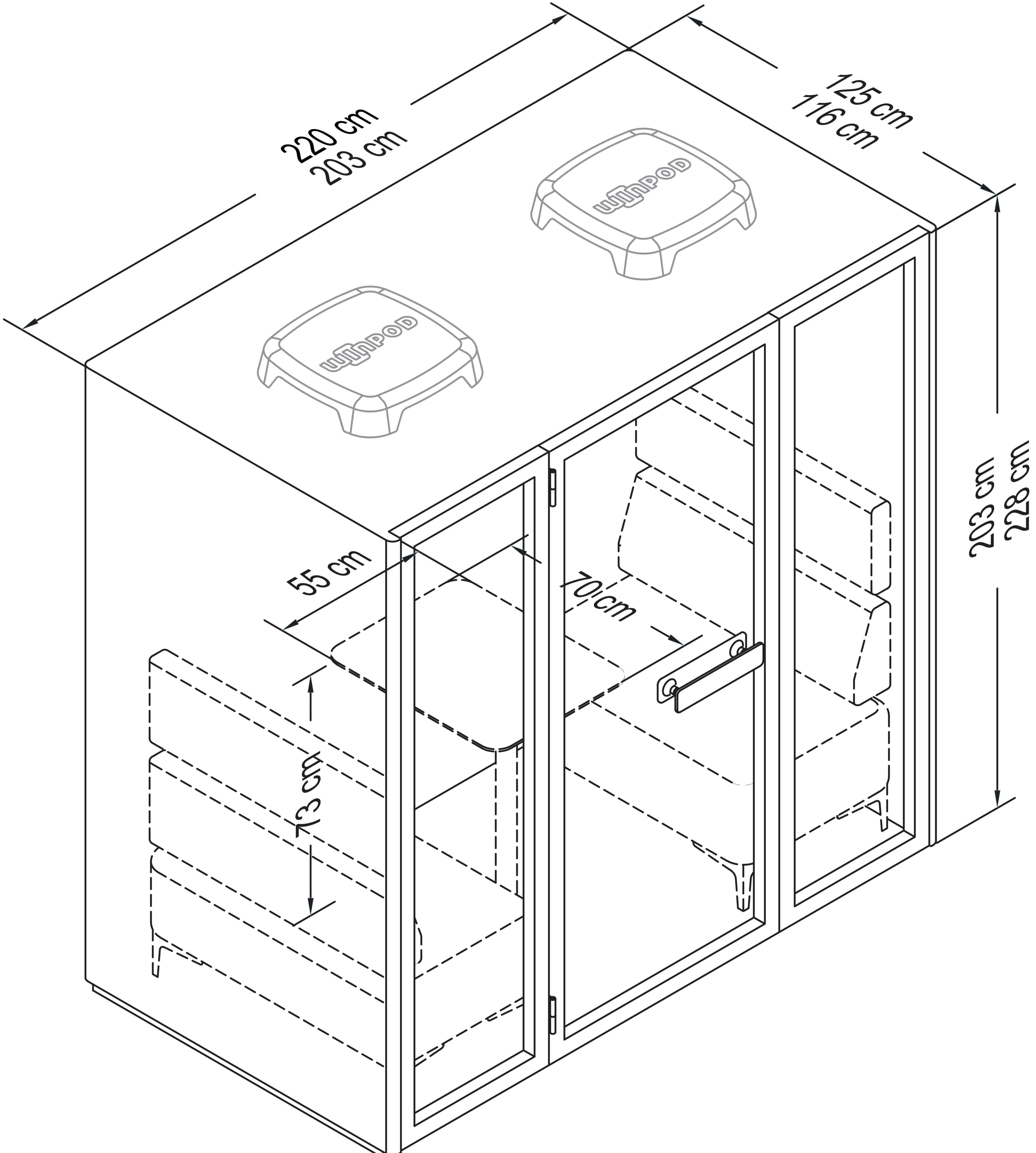

### Application

Commercial Office, Airport Lounge, Waiting Area, Library Space, Hotel Lobby & Reception, Institutions, Showroom

### UNIQUE FEATURES

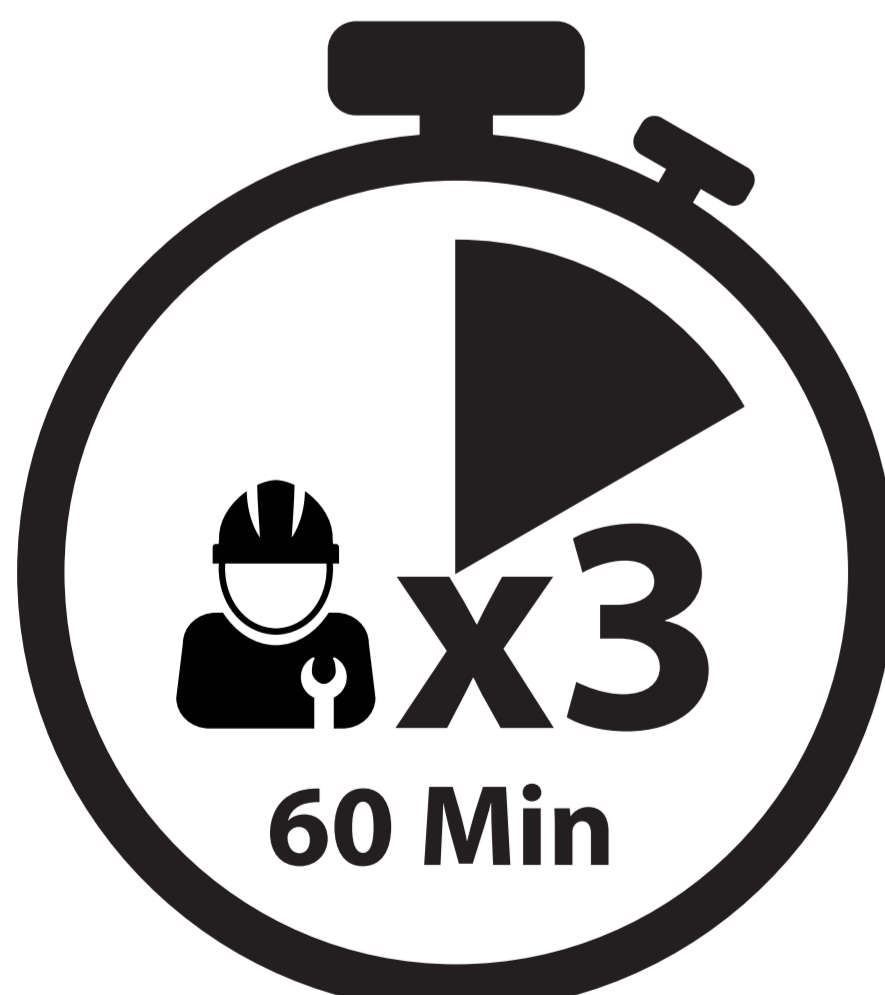

Quick & Easy Assembly



Multiple Colour Option for Sofa Fabric

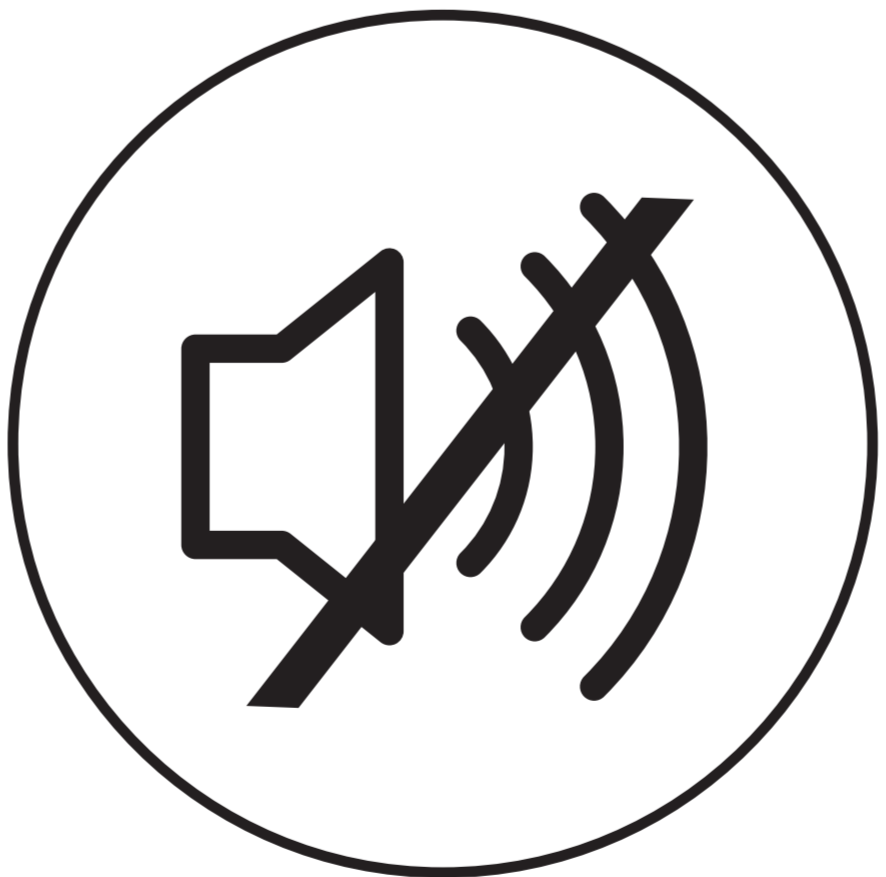

High Acoustic Rating  
Tested by TÜV SÜD  
(ISO 23351-1 Standard)

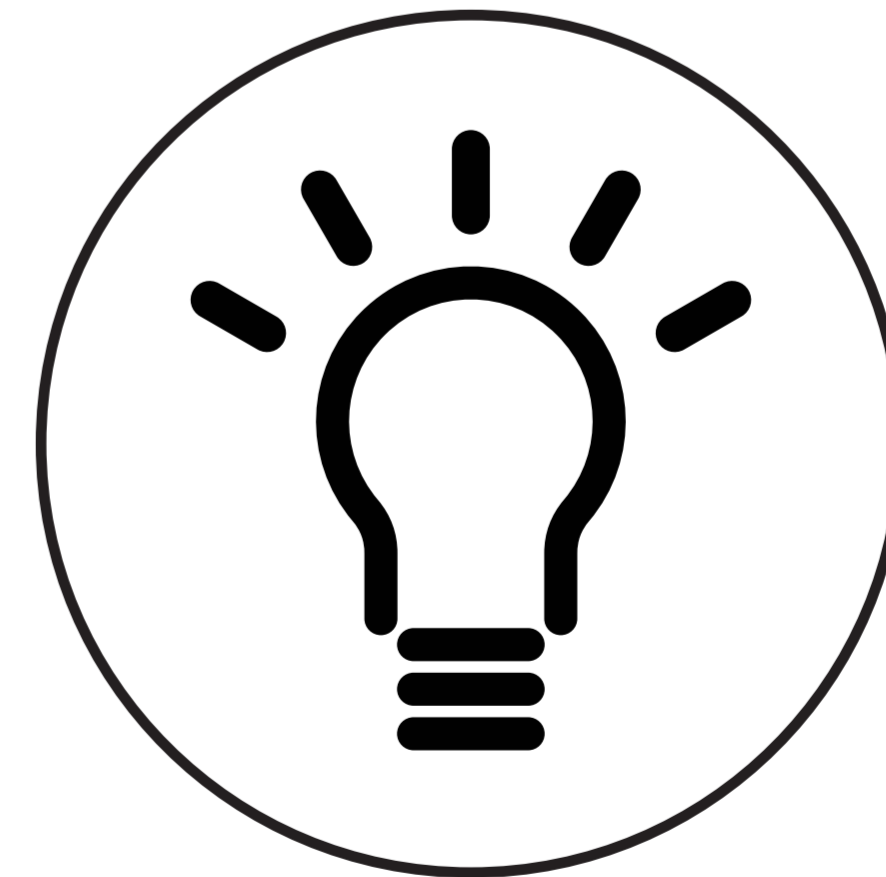

Occupancy Indicator Light

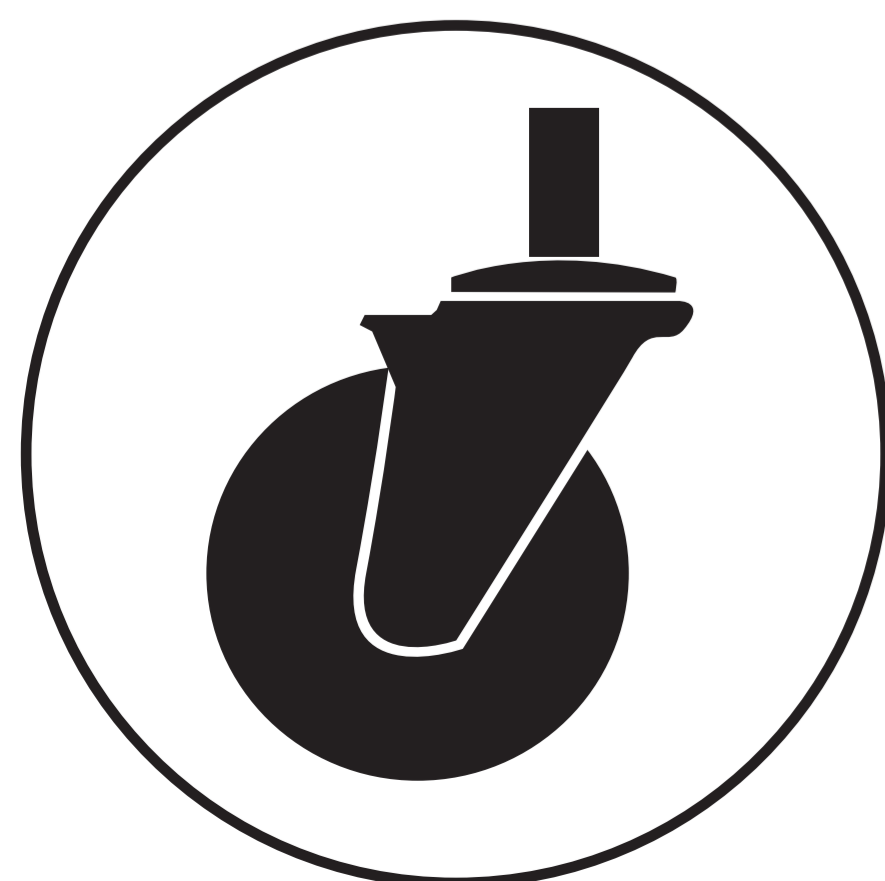

Build In with Heavy Duty Castor

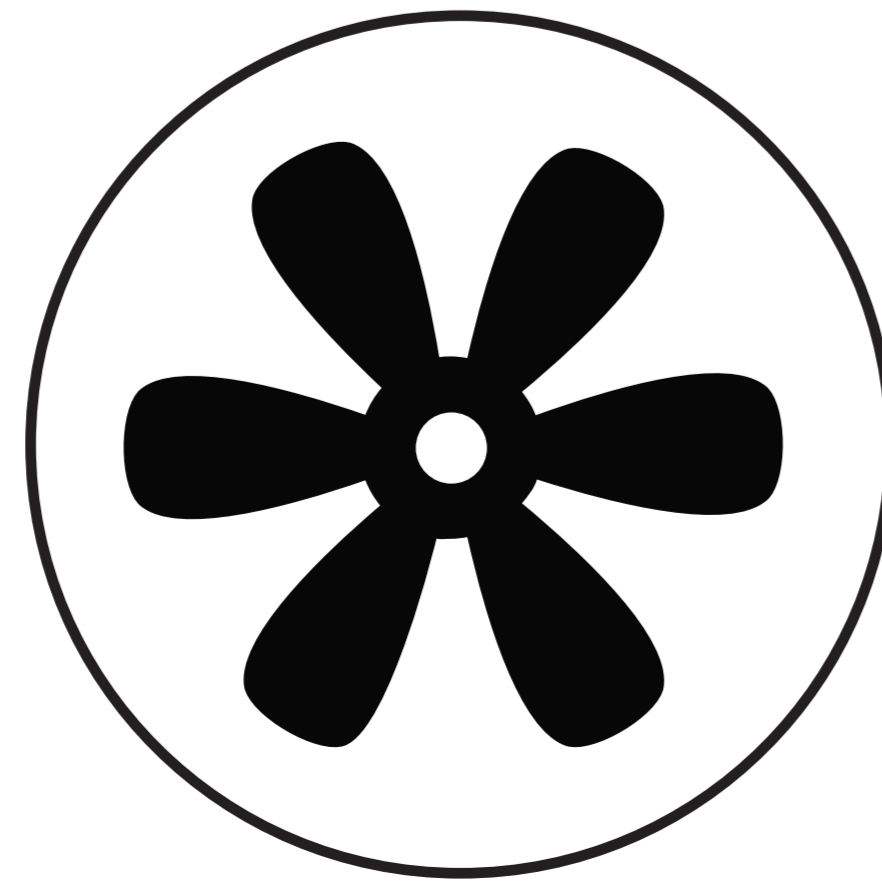

Smart Ventilation System with Pre Filter



Integrated Touch Panel System

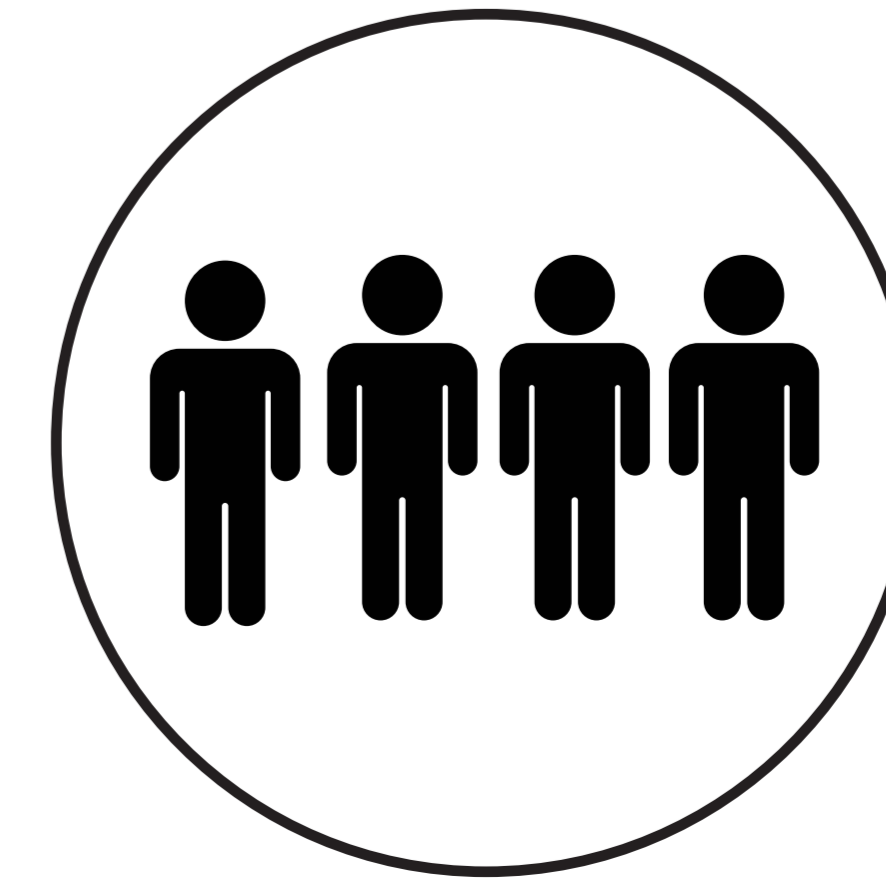

Occupancy up to 4 Pax

# winpod

BY WINTECH®

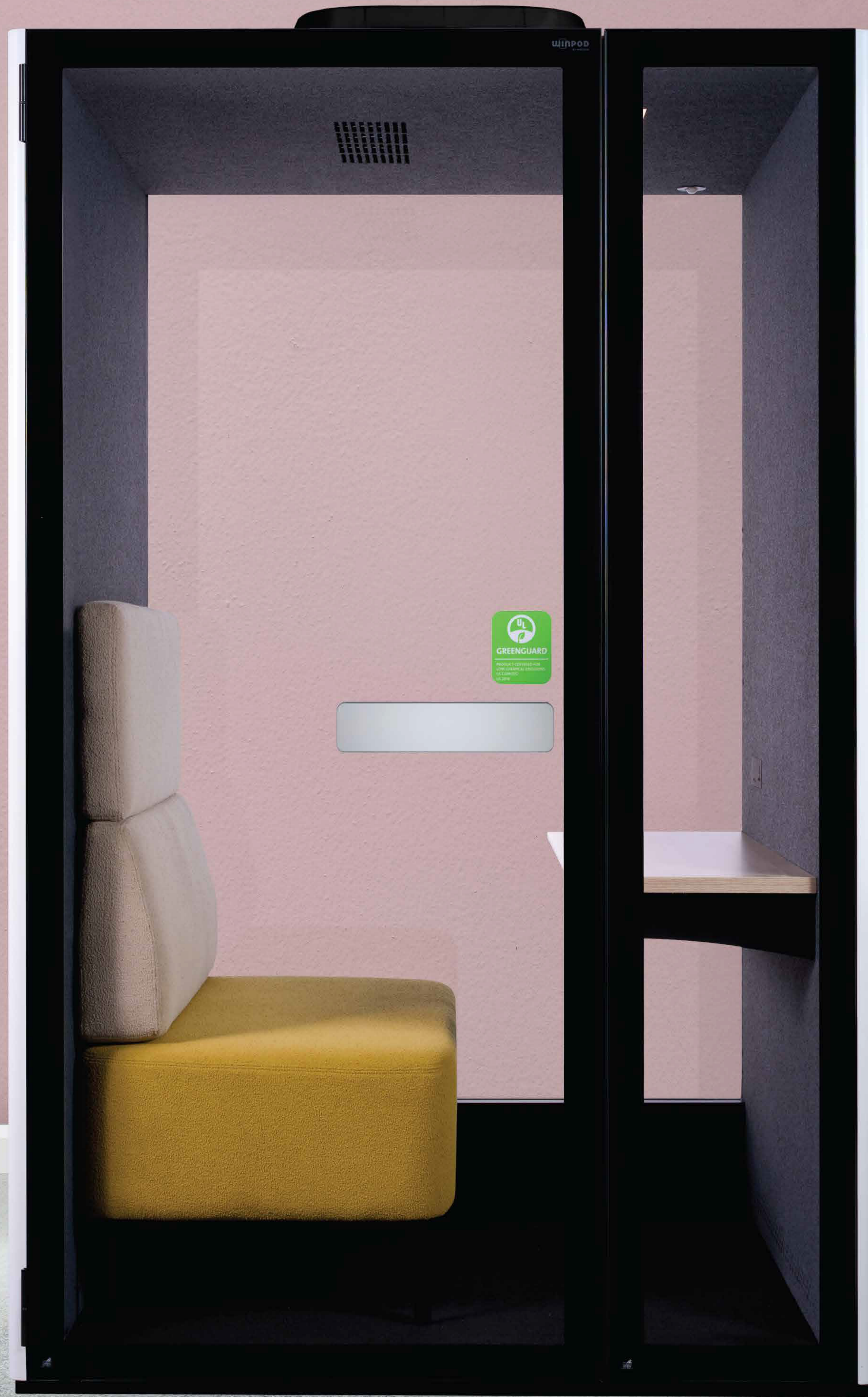

[www.winpod.co.th](http://www.winpod.co.th)

# W POD 3.0

## PLUS SERIES

W POD 3.0 has a unique extendable desktop with multiple functions. This ergonomis feature allows you to adjust your working position, while providing a storage space. this spacious pod is suitable for individual who wants to work over a long period of time,

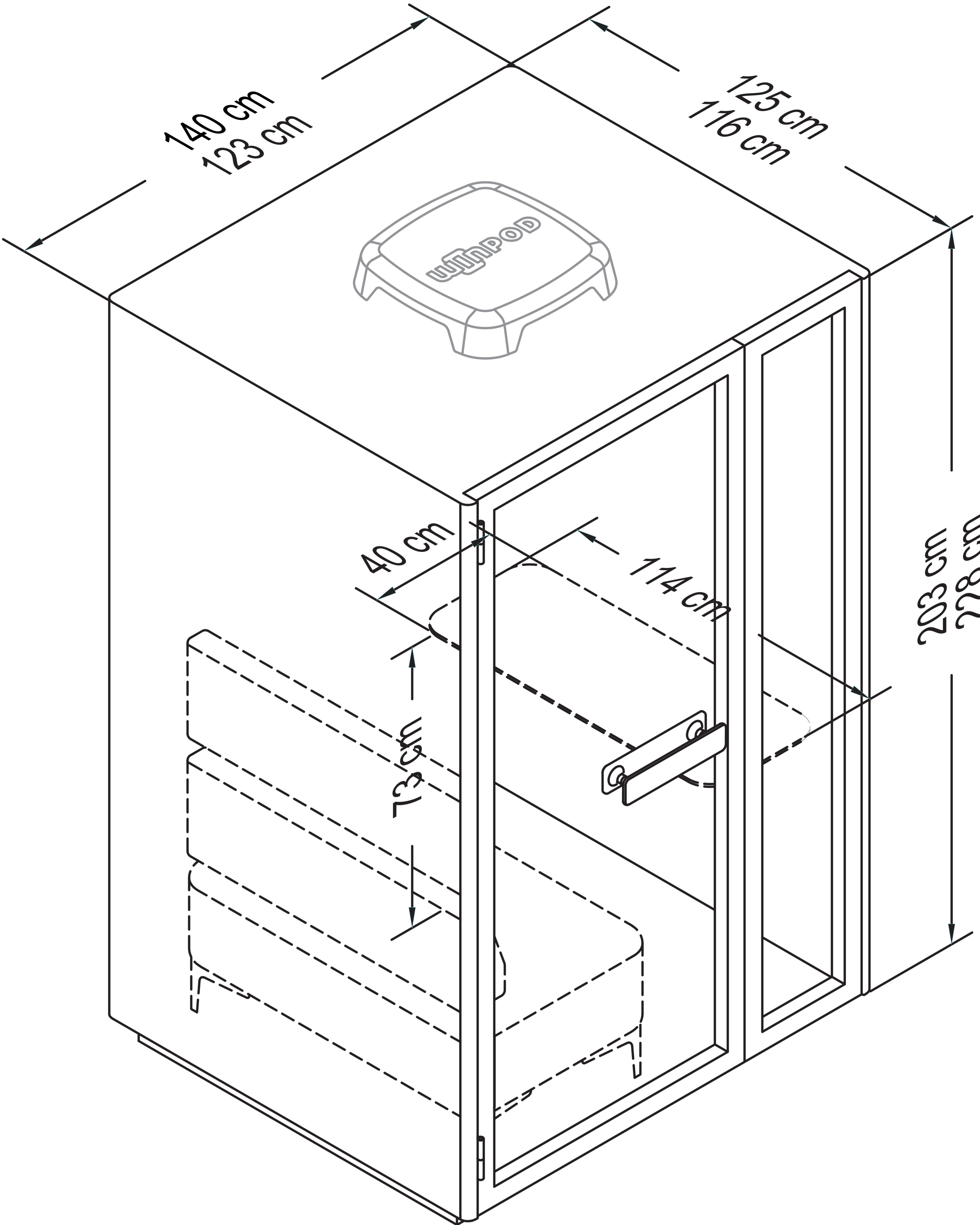

### Application

Commercial Office, Airport Lounge, Waiting Area, Library Space, Hotel Lobby & Reception, Institutions, Showroom

### UNIQUE FEATURES

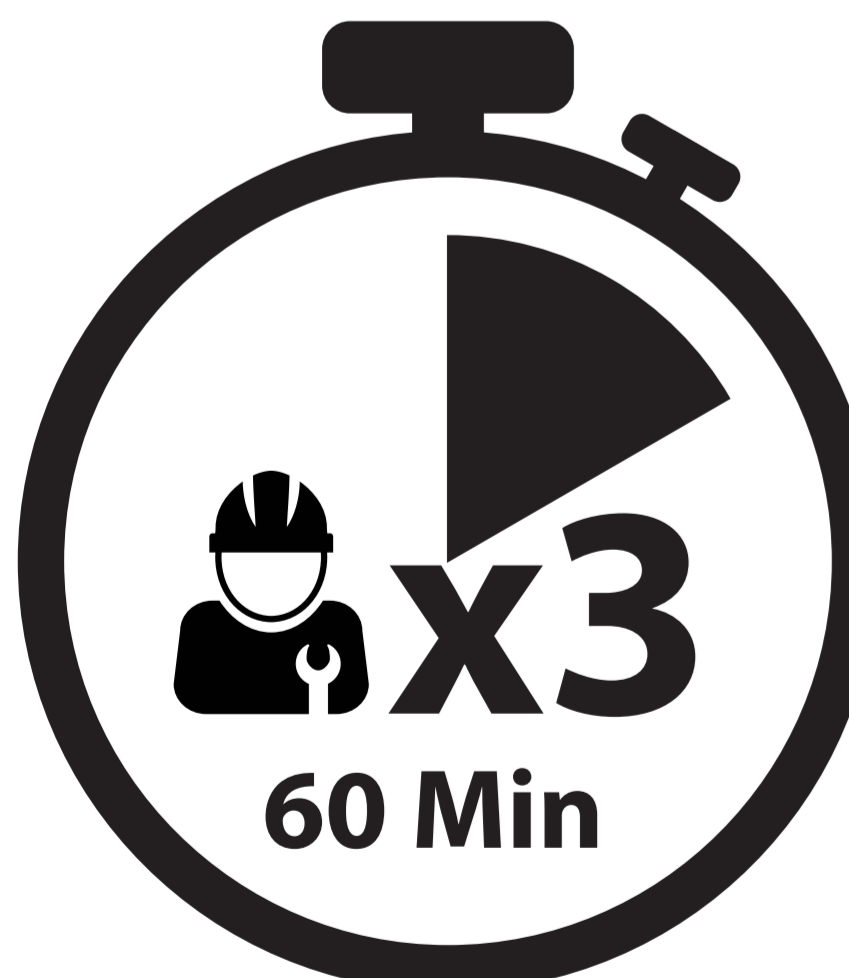

Quick & Easy Assembly



Multiple Colour Option for Sofa Fabric



High Acoustic Rating  
Tested by TÜV SÜD  
(ISO 23351-1 Standard)

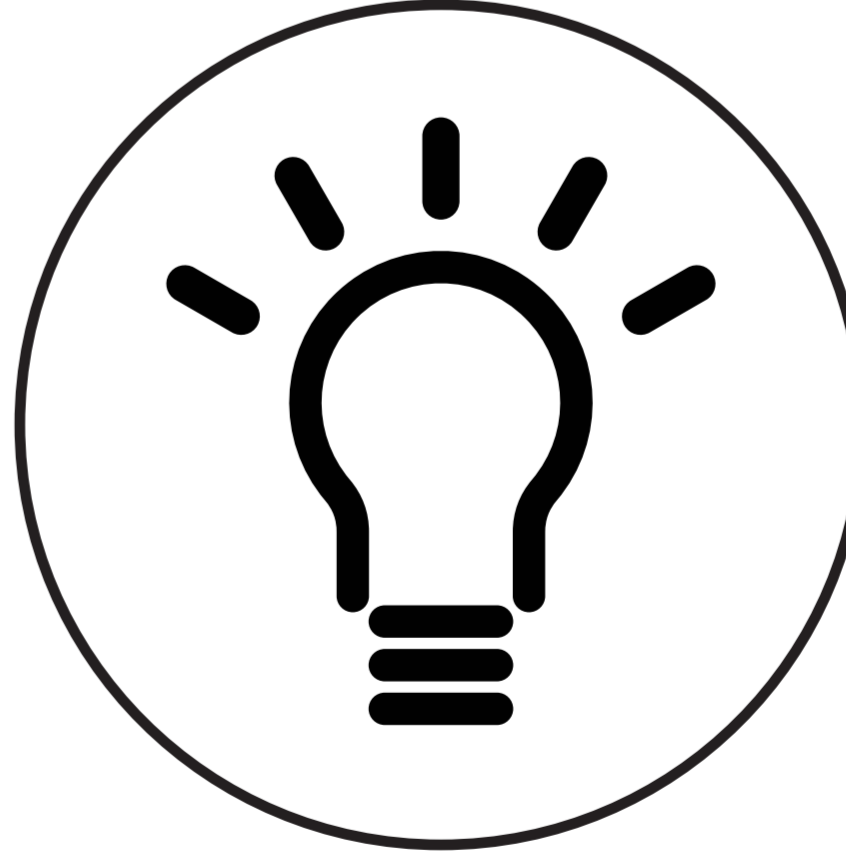

Occupancy Indicator Light

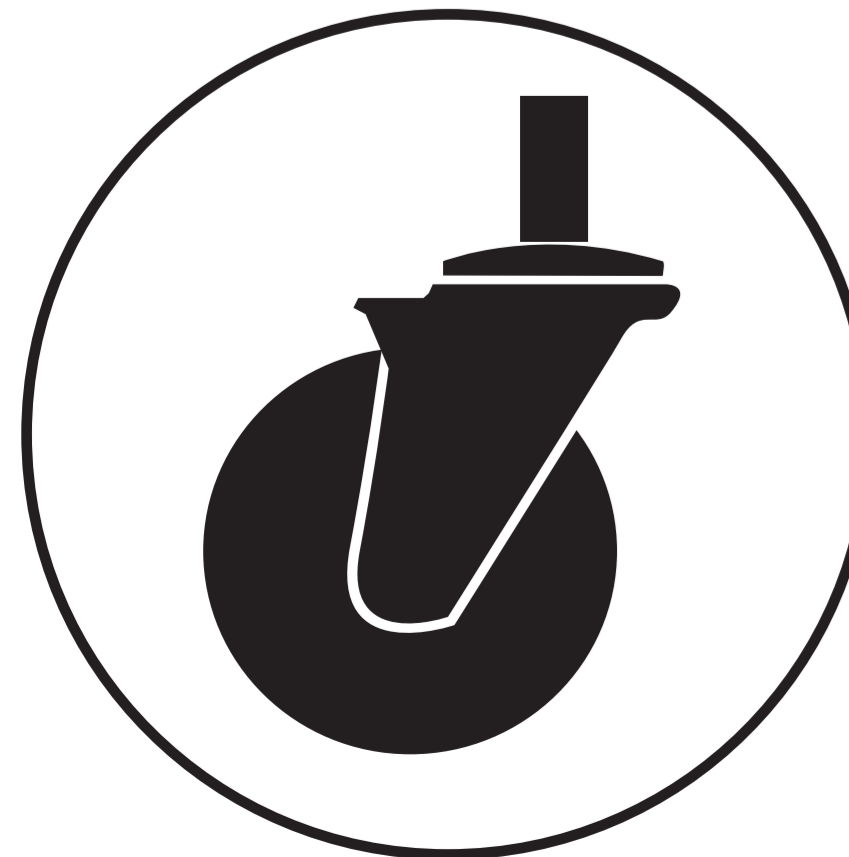

Build In with Heavy Duty Castor

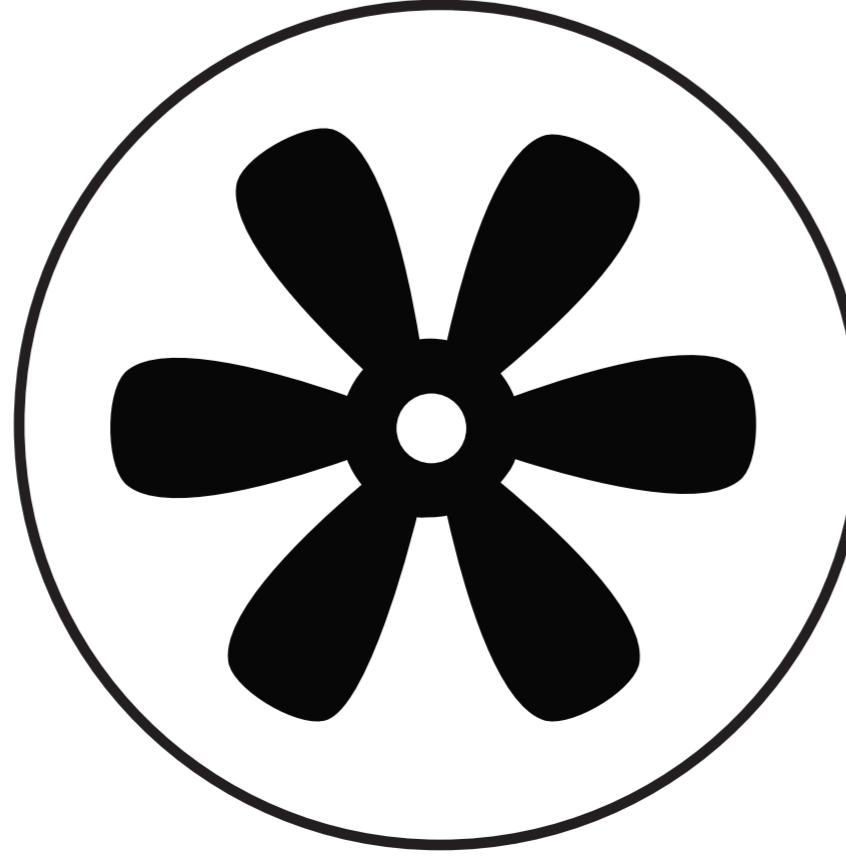

Smart Ventilation System with Pre Filter



Integrated Touch Panel System

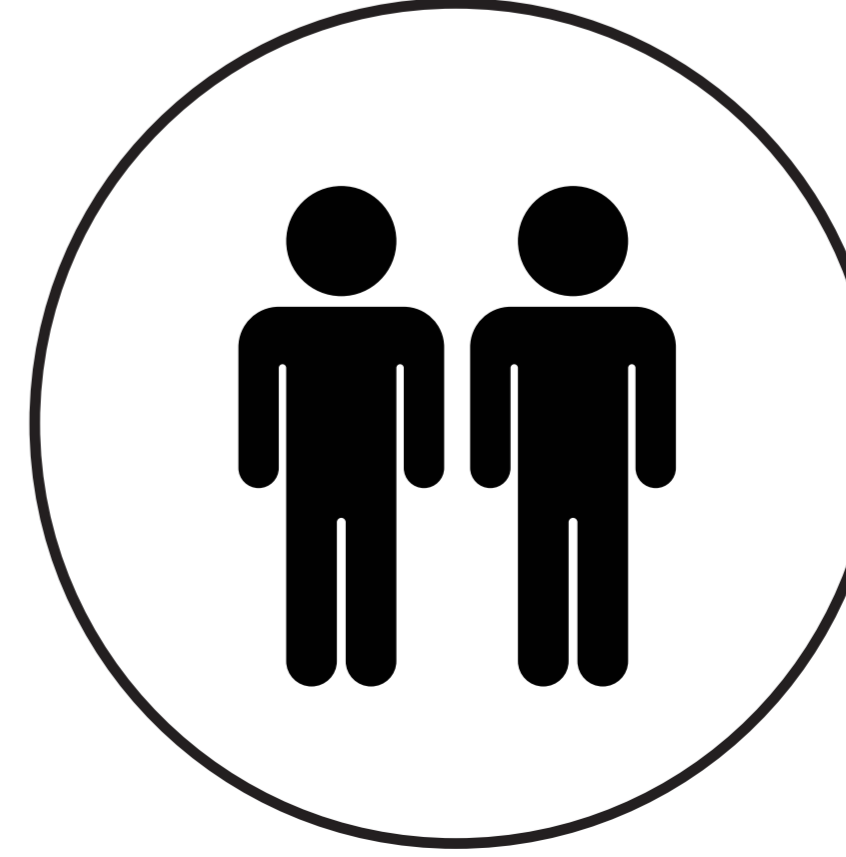

Occupancy up to 2 Pax

**winpod**  
BY WINTECH®



[www.winpod.co.th](http://www.winpod.co.th)

# C POD 3.0

## PLUS SERIES

C POD 3.0 is designed to fit up to five people, ideally for meeting, entertainment or relaxing. The meeting table with integrated charging ports are perfect for discussion and brainstorming. Choice of L-shaped sofa offers a casual yet private moments for folks.

### Application

Commercial Office, Airport Lounge, Waiting Area, Library Space, Hotel Lobby & Reception, Institutions, Showroom

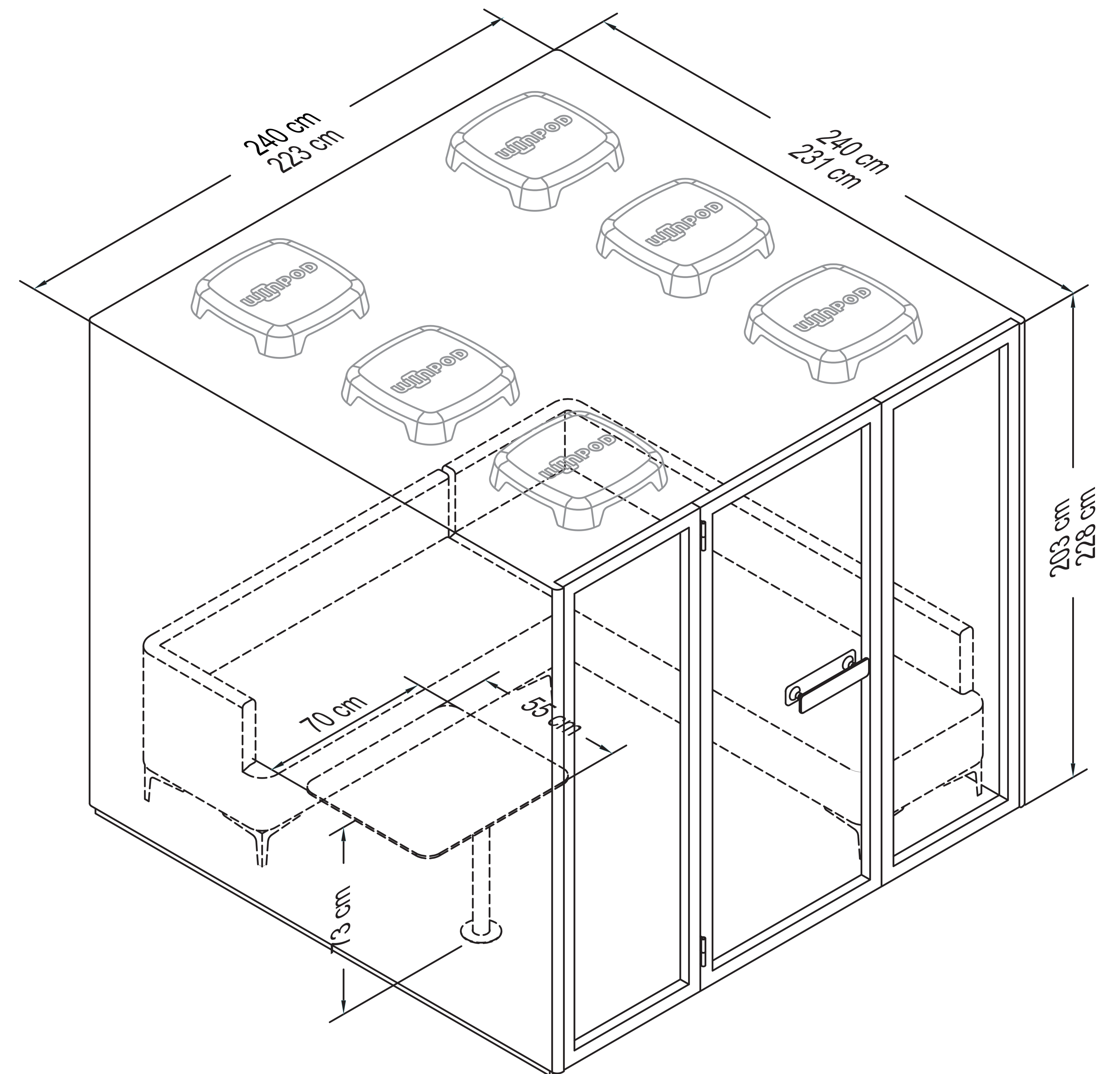

### UNIQUE FEATURES

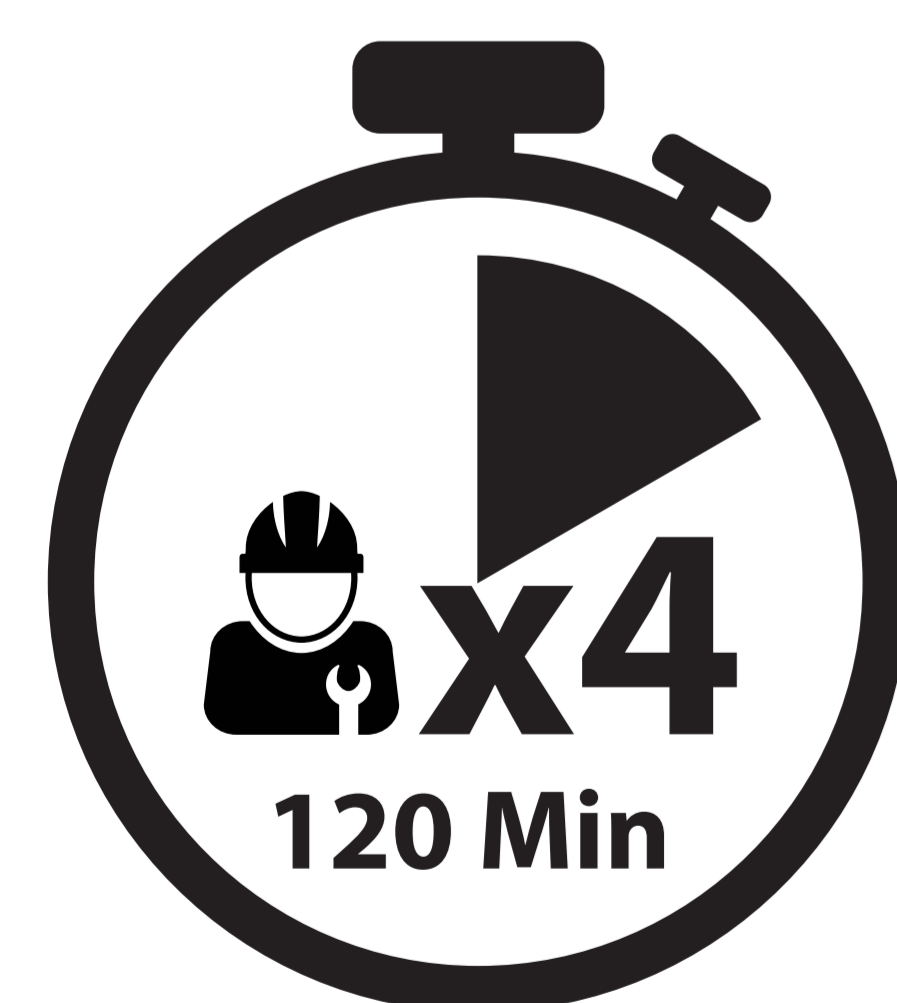

Quick & Easy  
Assembly



Wheel Chair  
Accessible (\*Optional)



High Acoustic Rating  
Tested by TÜV SÜD  
(ISO 23351-1 Standard)

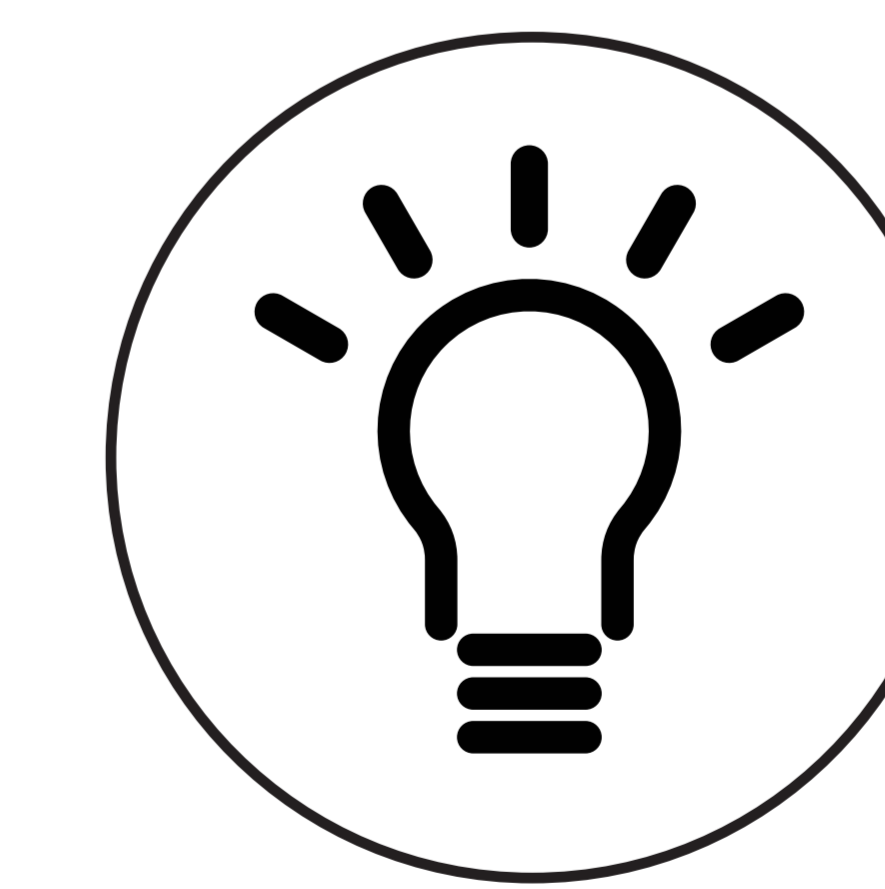

Occupancy Indicator  
Light

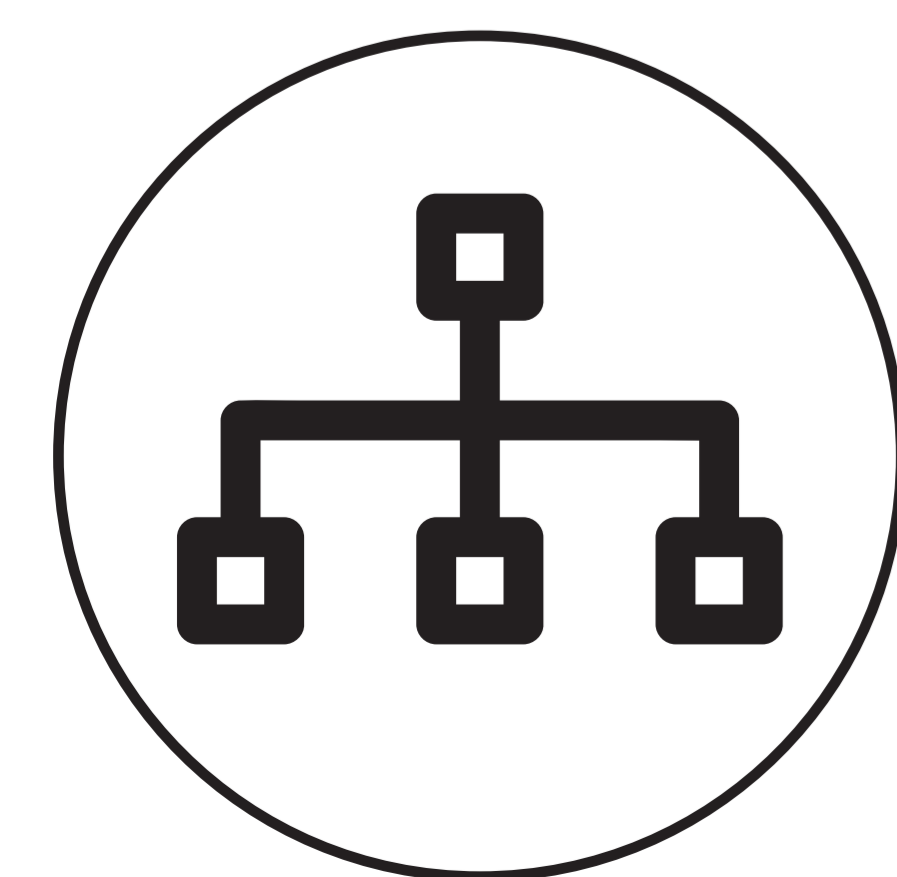

Advance Booking  
System (\*Optional)

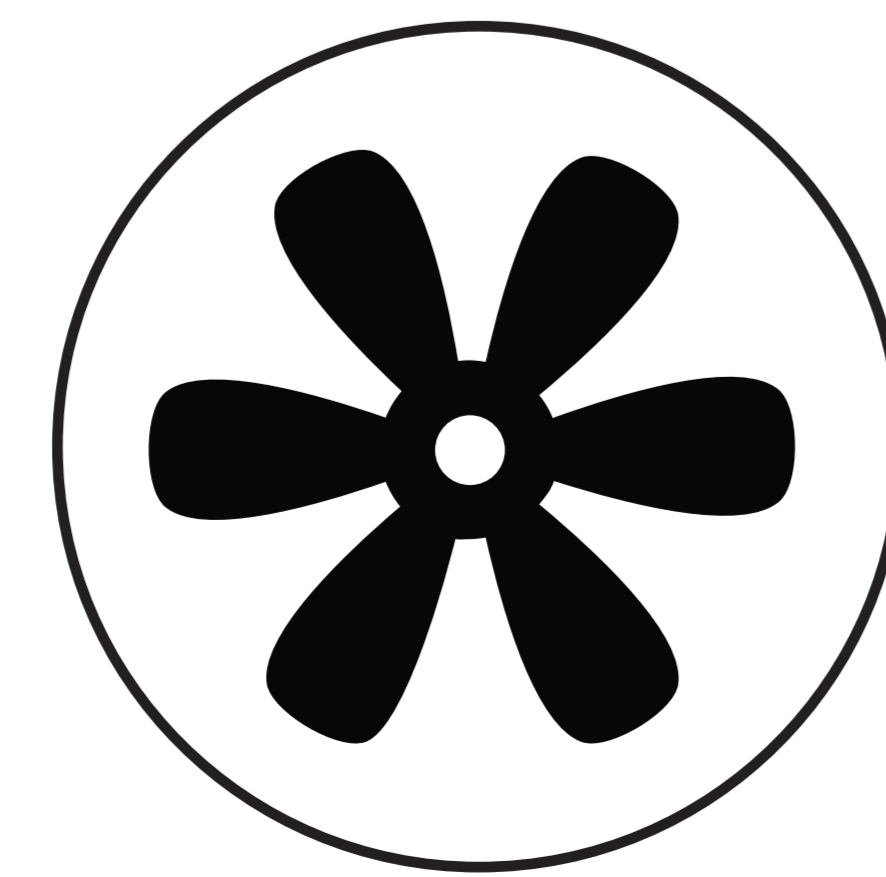

Smart Ventilation  
System with Pre Filter

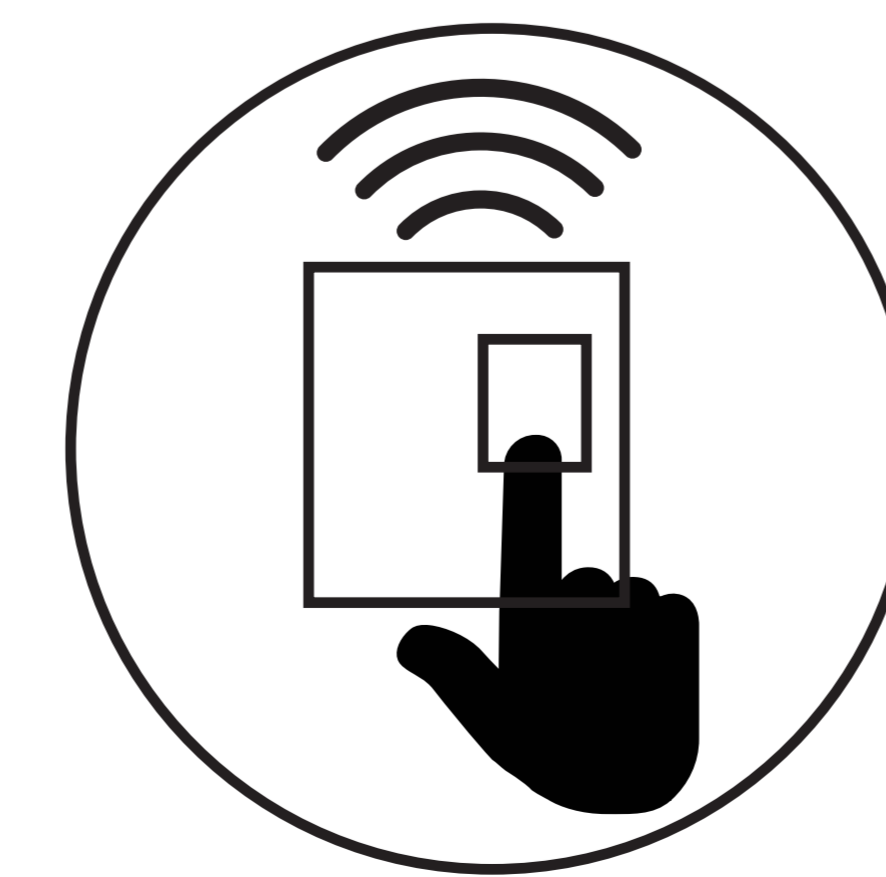

Integrated Touch  
Panel System

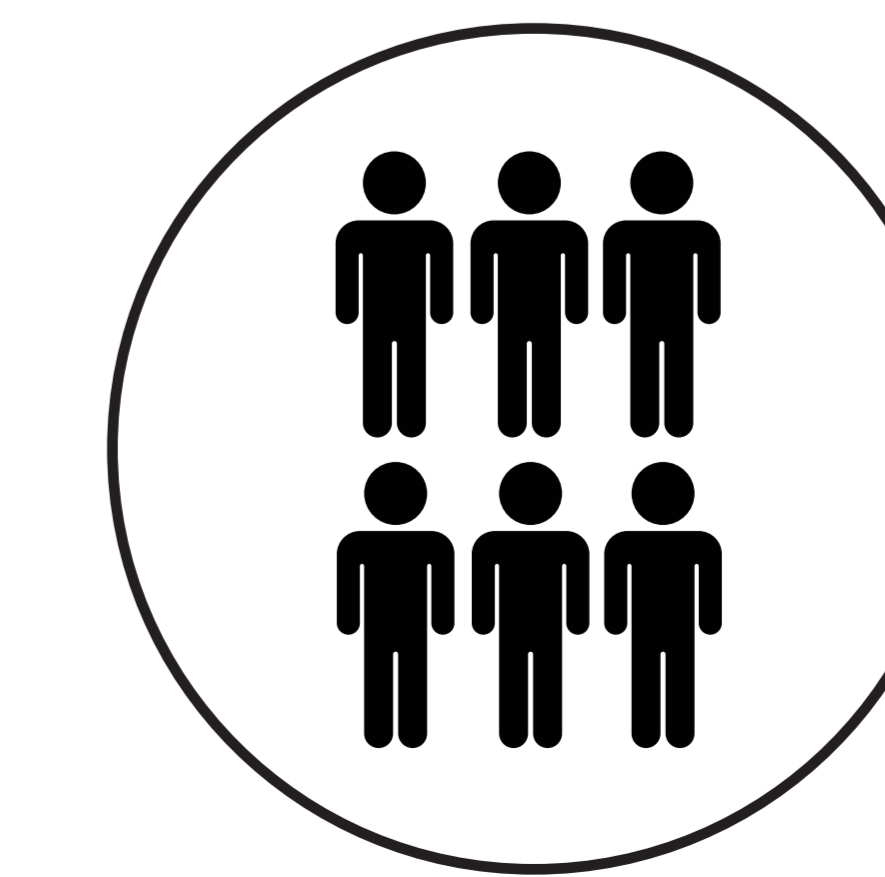

Occupancy up to 6 Pax

**winpod**  
BY WINTECH®



[www.winpod.co.th](http://www.winpod.co.th)

# M POD 3.0

## PLUS SERIES

M POD 3.0 can accommodate up to seven persons. Its comfortable and well-ventilated space can help users to increase work efficiency and productivity.

Apart from the meeting table and L-shaped sofa, a bare unit is also available for your personal option to furnish it.

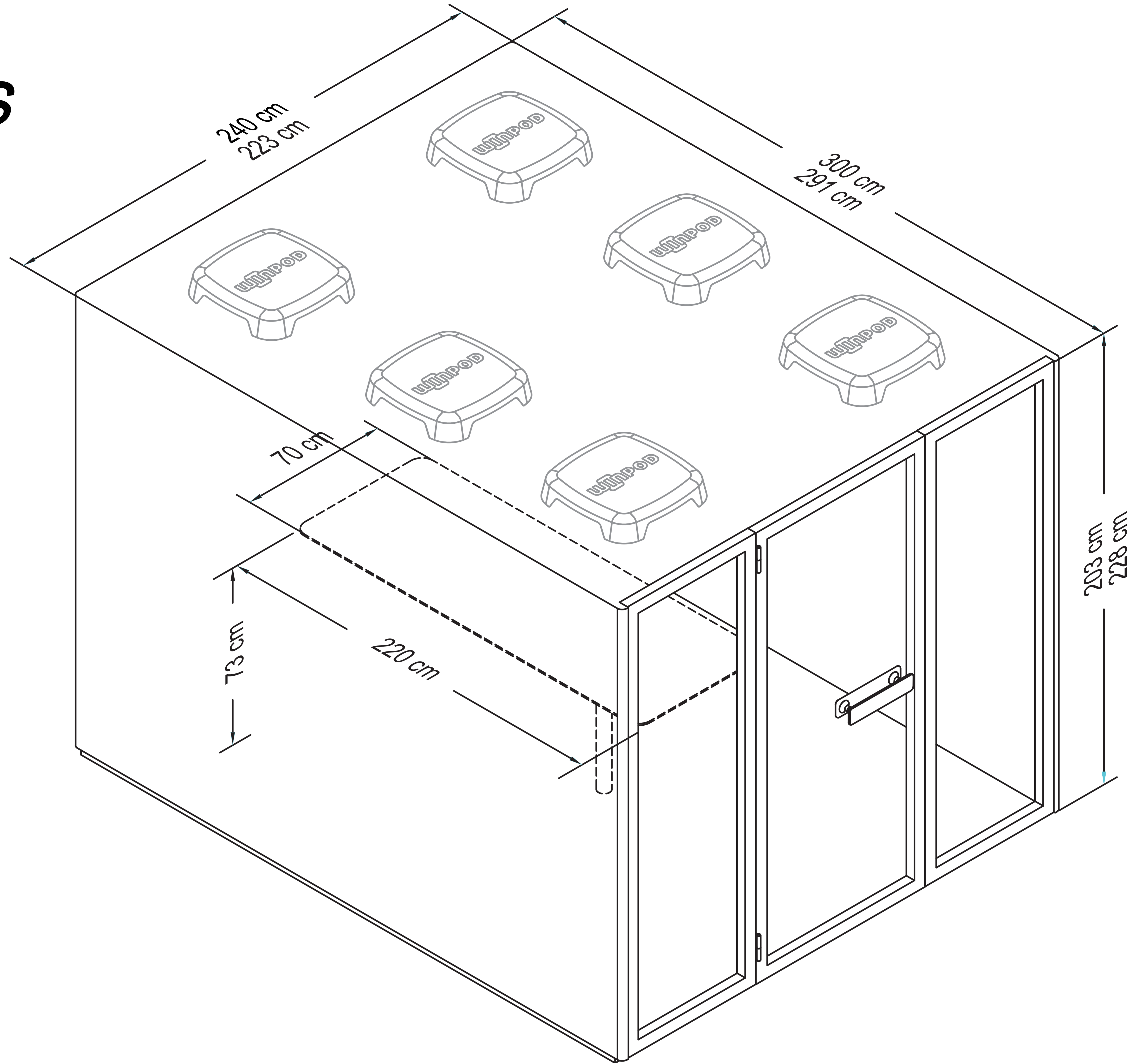

### Application

Commercial Office, Airport Lounge, Waiting Area, Library Space, Hotel Lobby & Reception, Institutions, Showroom

### UNIQUE FEATURES

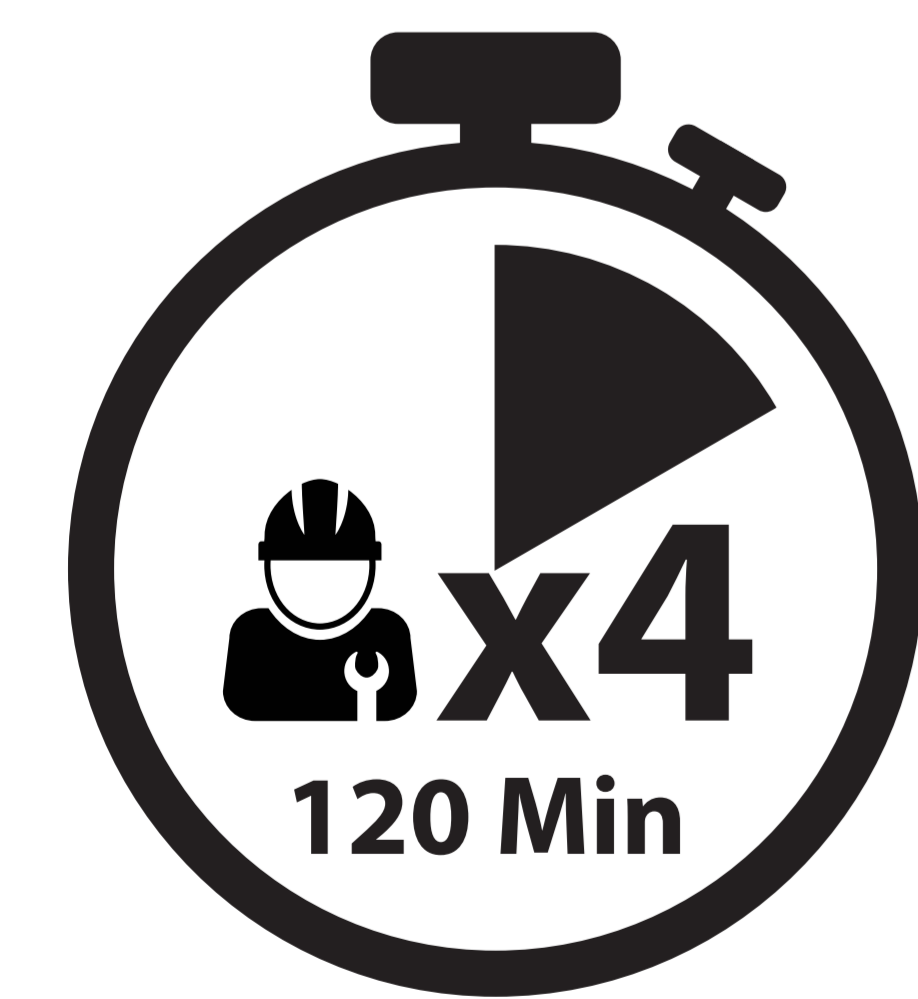

Quick & Easy Assembly



Wheel Chair Accessible (\*Optional)

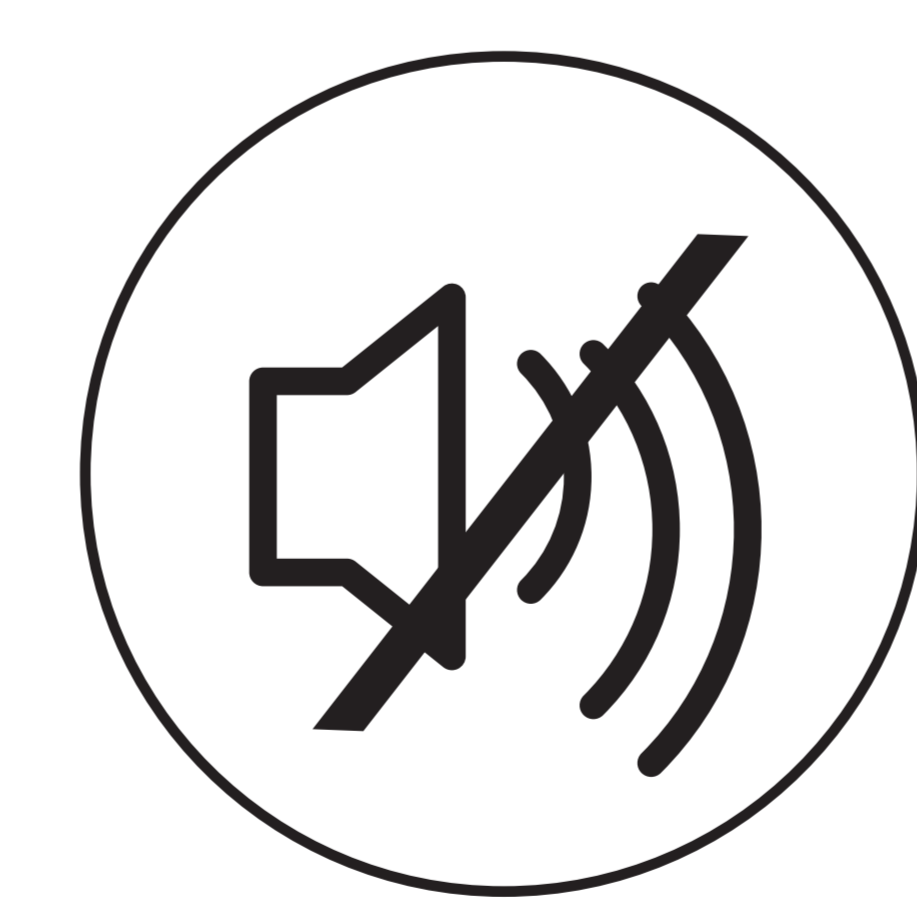

High Acoustic Rating  
Tested by TÜV SÜD  
(ISO 23351-1 Standard)

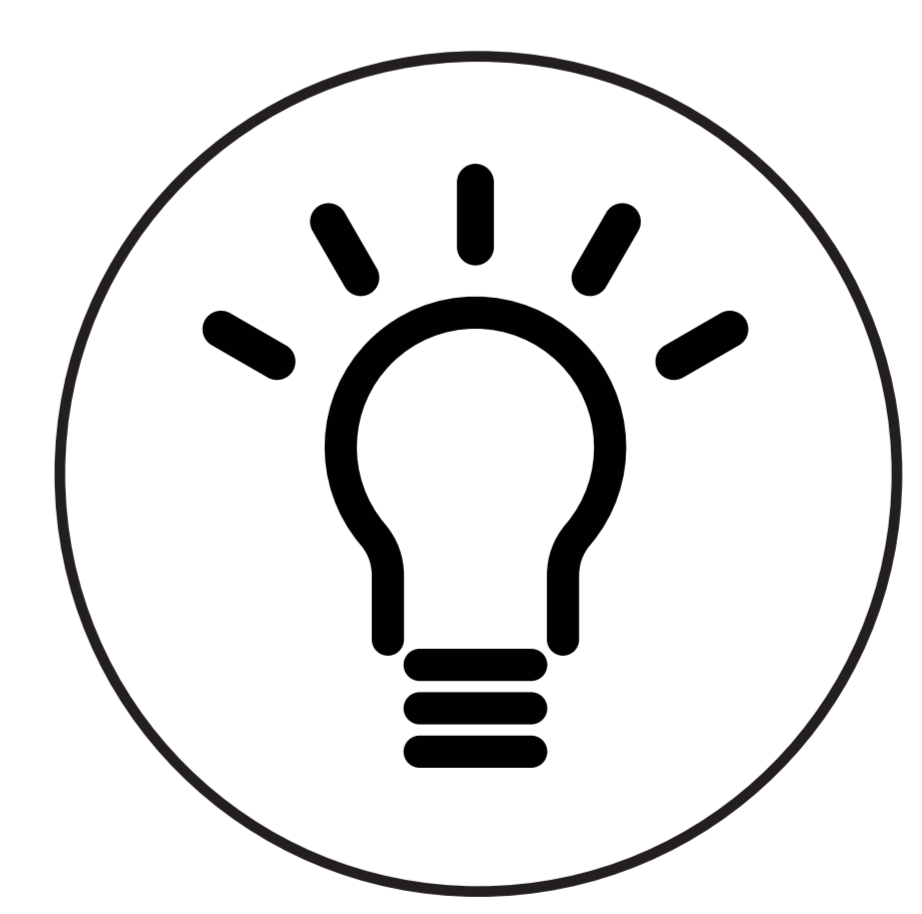

Occupancy Indicator Light

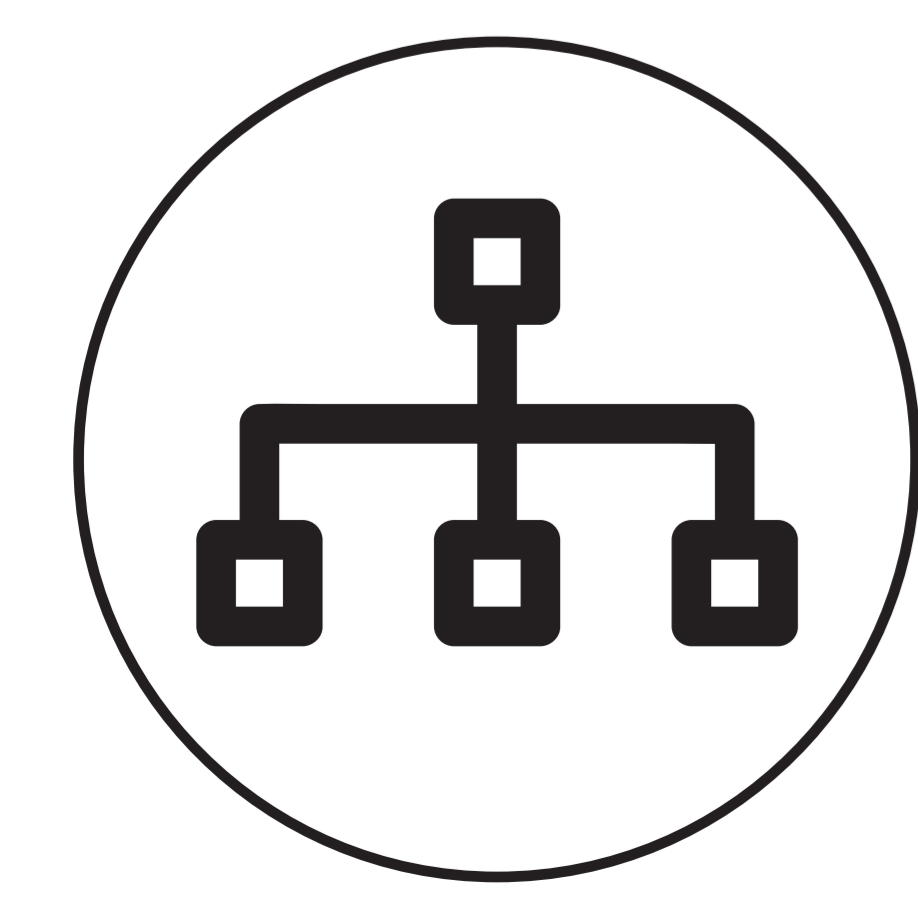

Advance Booking System (\*Optional)

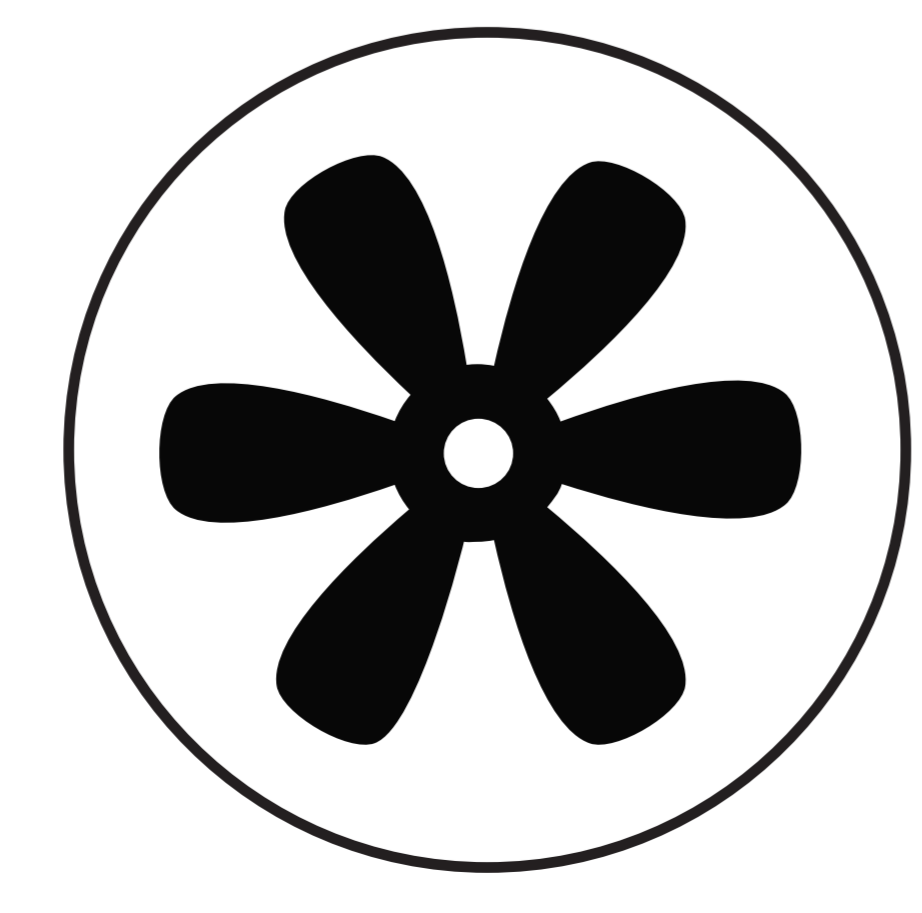

Smart Ventilation System with Pre Filter

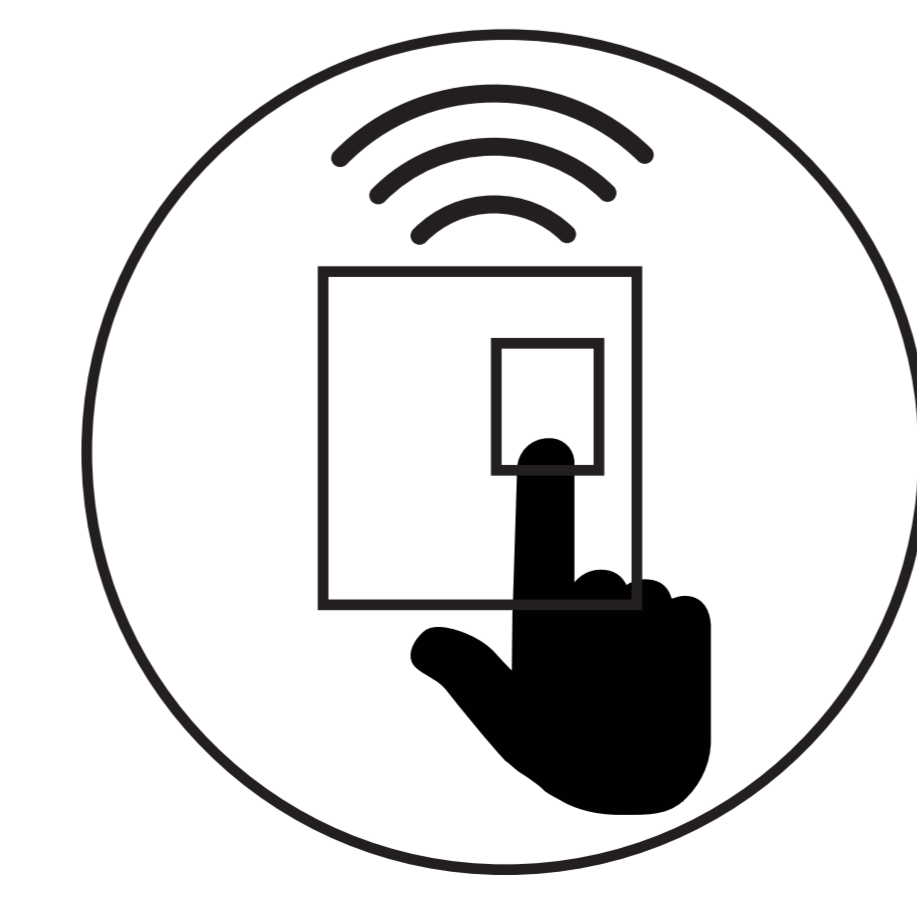

Integrated Touch Panel System

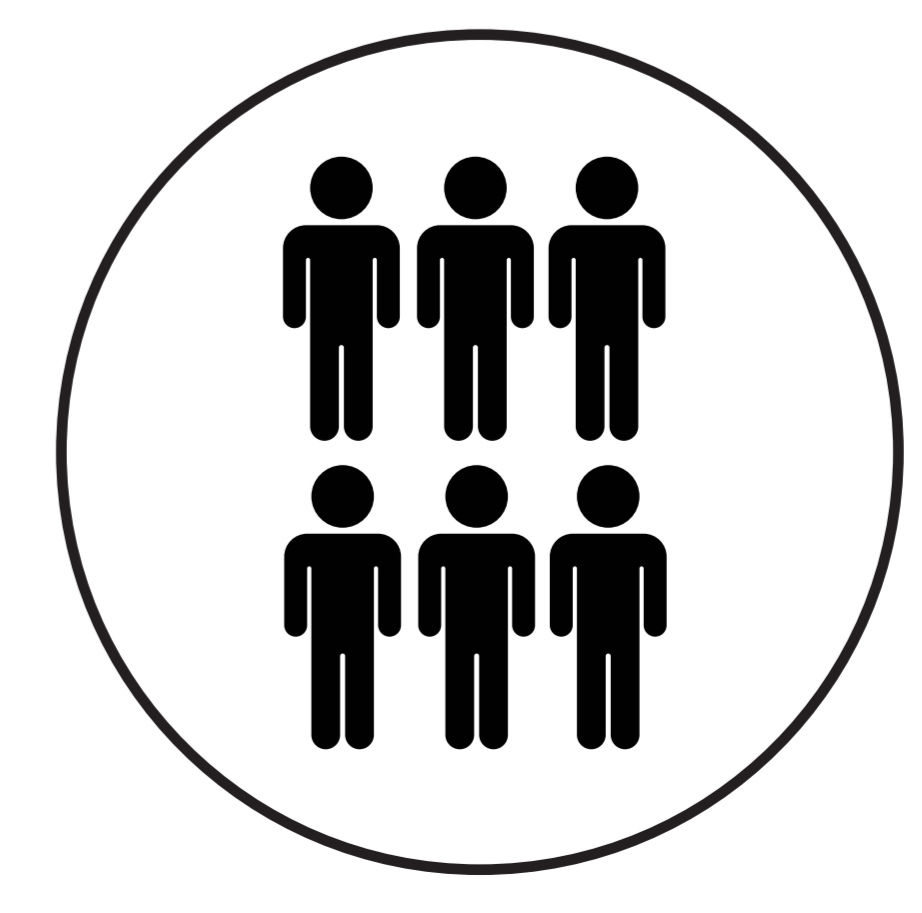

Occupancy up to 6 Pax

# winpod

BY WINTECH<sup>®</sup>

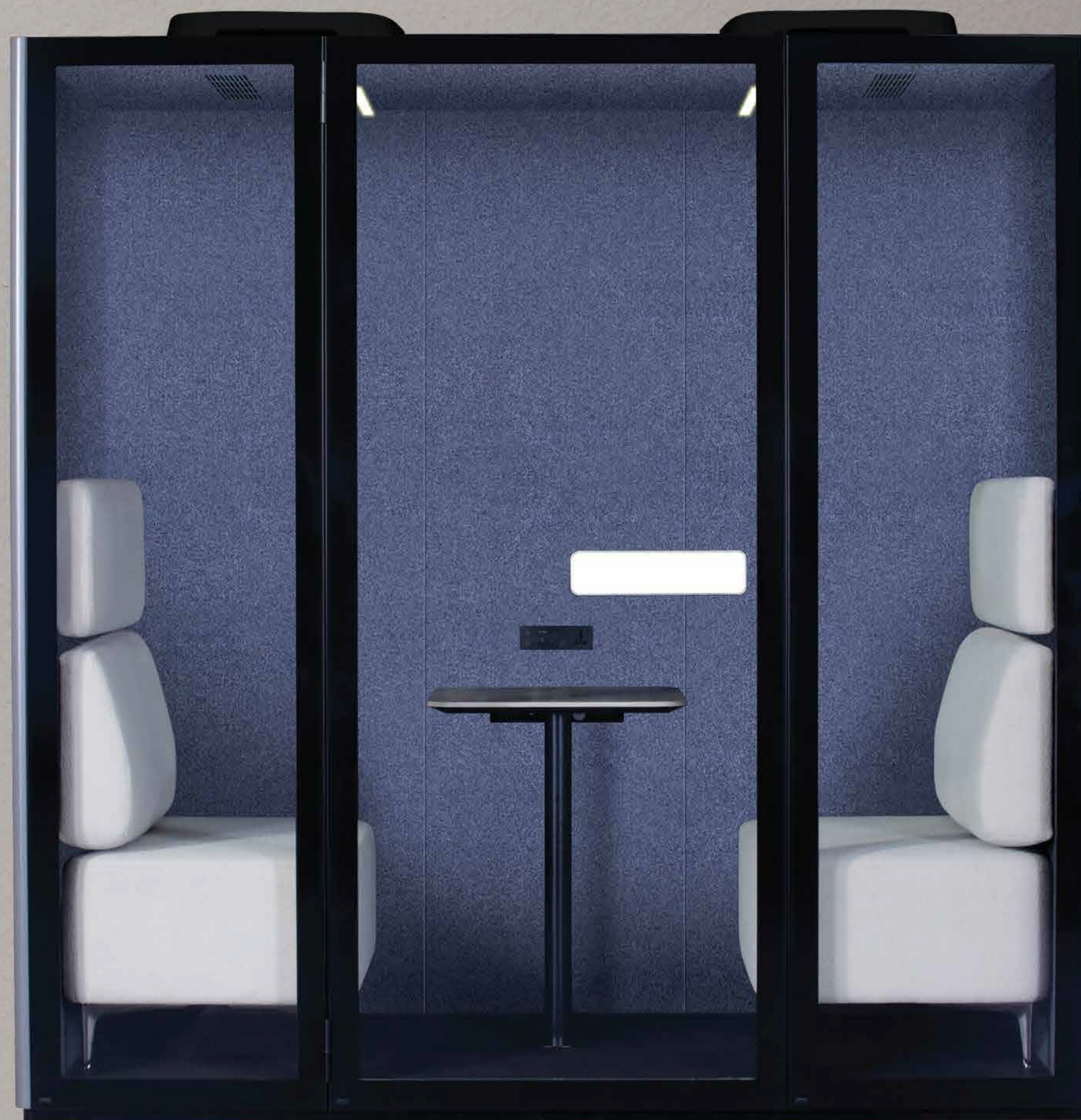
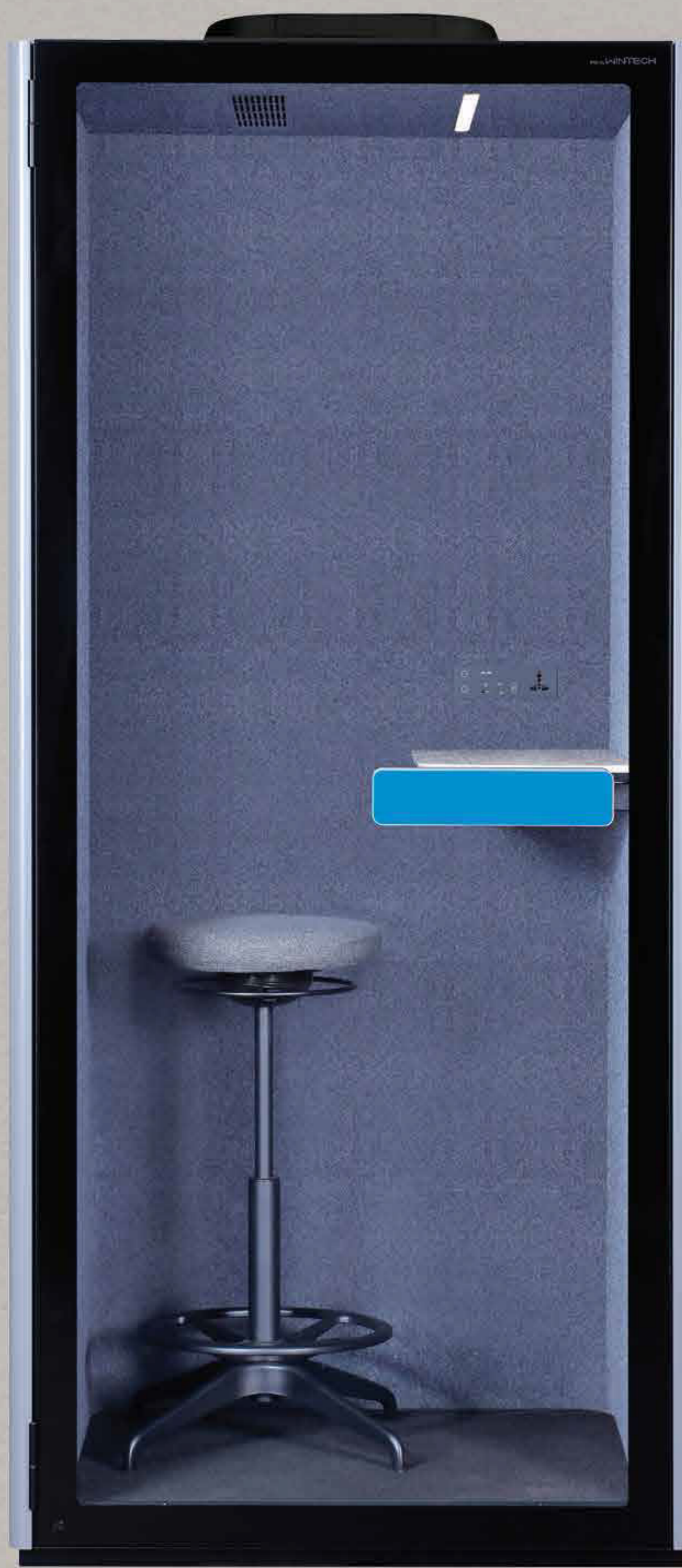

[www.winpod.co.th](http://www.winpod.co.th)

# POD 3.0

## PLUS SERIES

### PANEL SERIES

All Winpod Panel Series are mainly the same as 3.0, the only difference is the back panel, which is fully walled or without glass at the rear.



## UNIQUE FEATURES

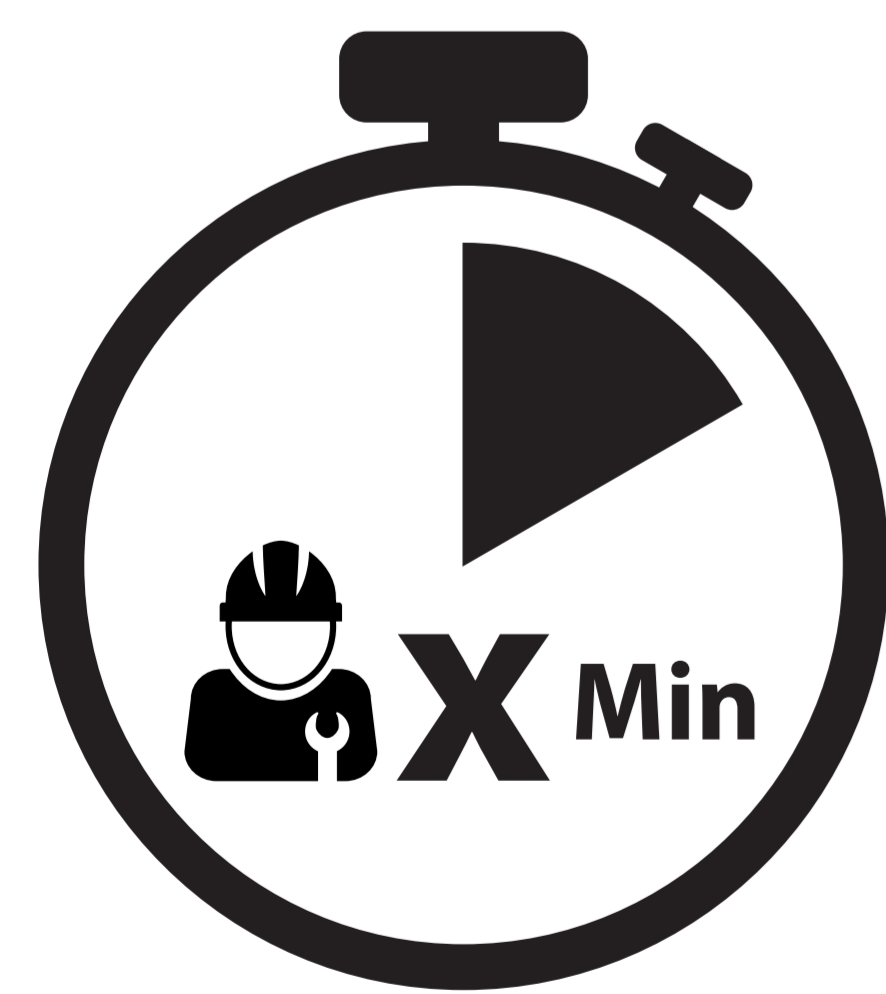

Quick & Easy Assembly



High Acoustic Rating  
Tested by TÜV SÜD  
(ISO 23351-1 Standard)

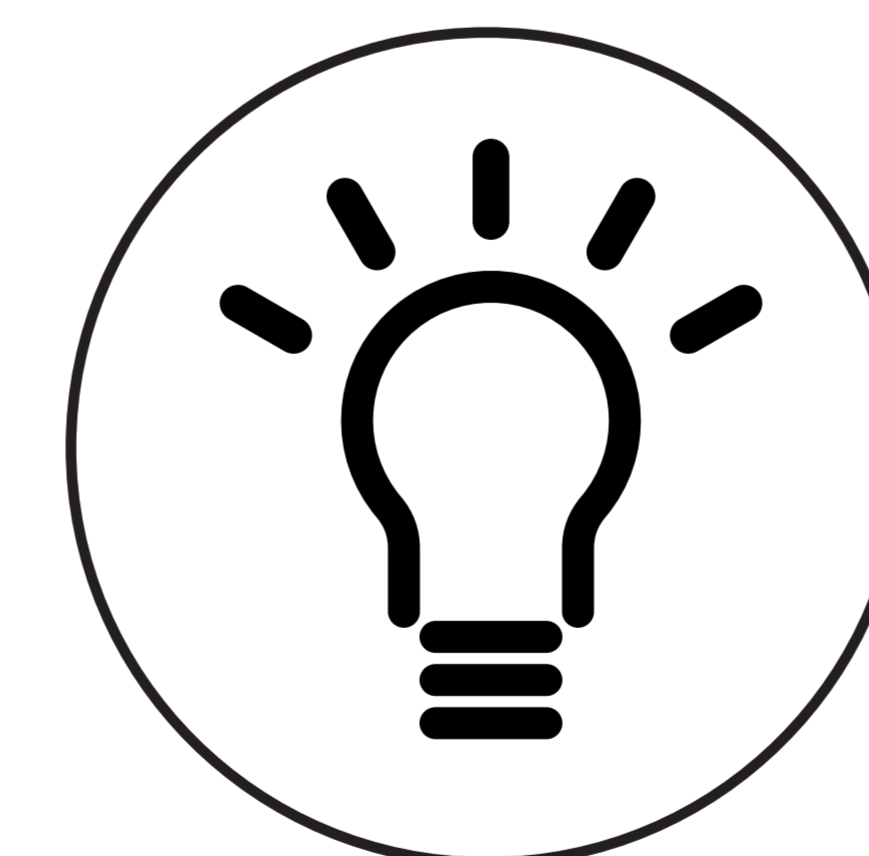

Occupancy Indicator Light

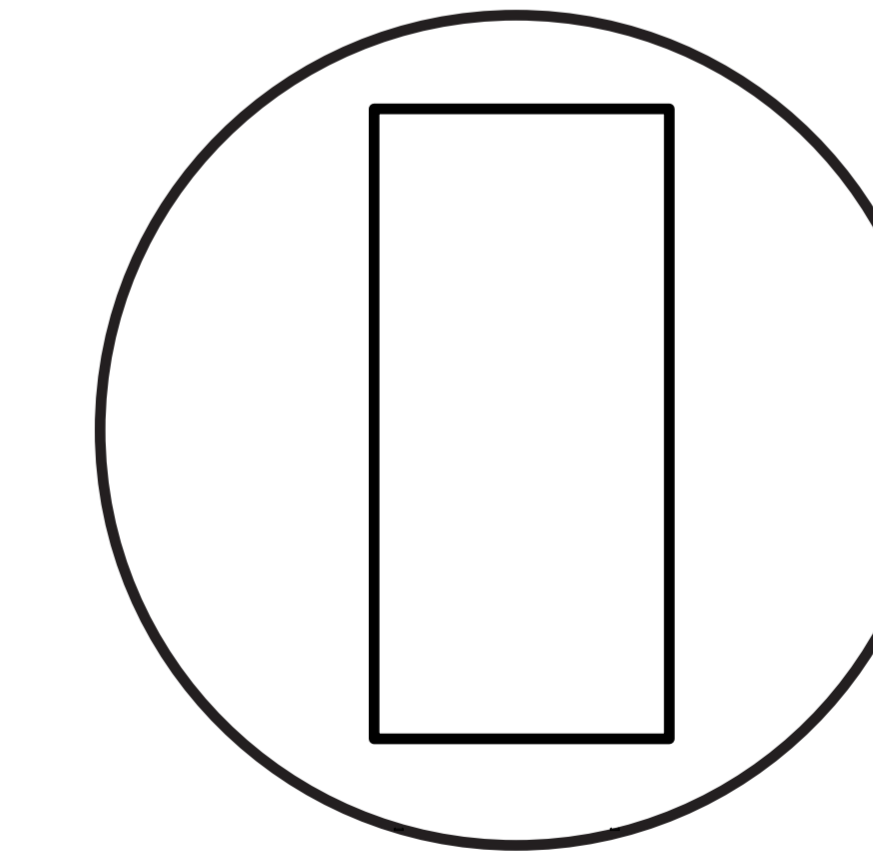

Solid Rear Panel

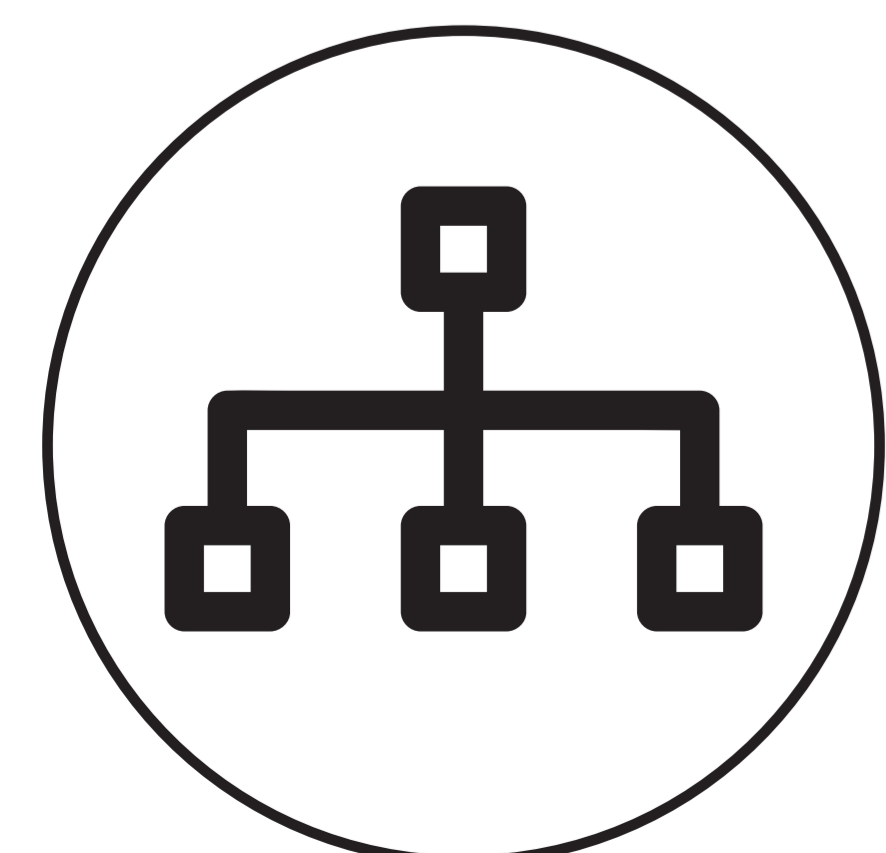

Intergrated Control Hub  
(C/D/W/MPOD Only)

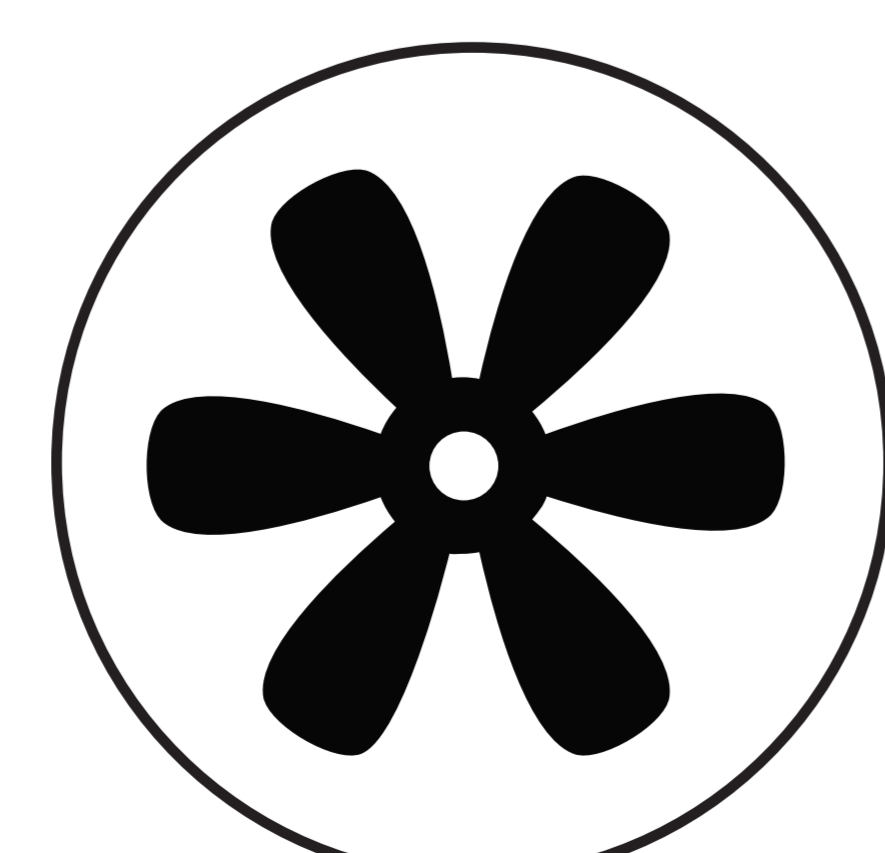

Smart Ventilation System with Pre Filter

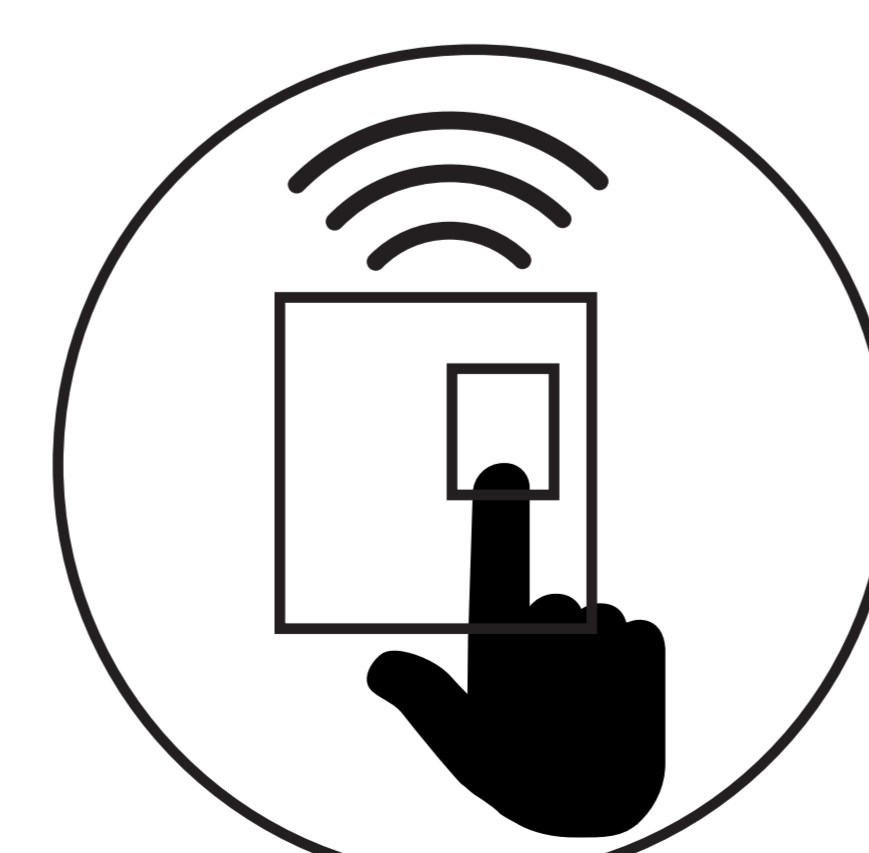

Integrated Touch Panel System

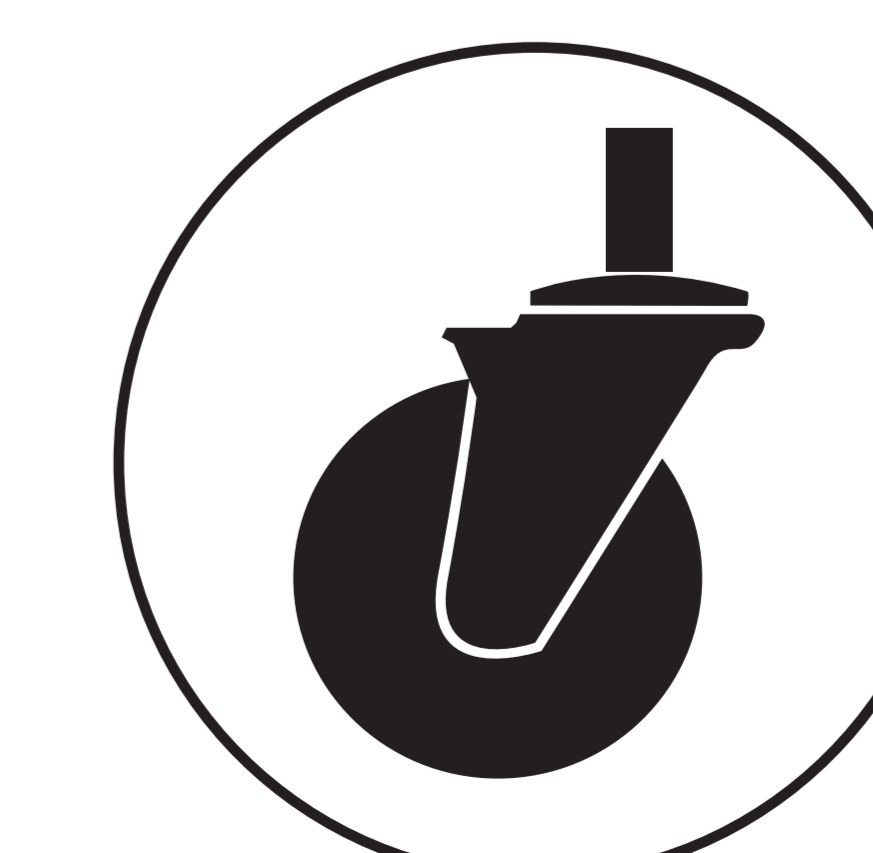

Build In With Heavy Duty Castor  
(S/W/DPOD Only)

**winpod**  
BY WINTECH®



Maximum 1150mm

Minimum 750mm

# Smart Adjustable Desk



[www.winpod.co.th](http://www.winpod.co.th)

# POD 3.0

## PLUS SERIES

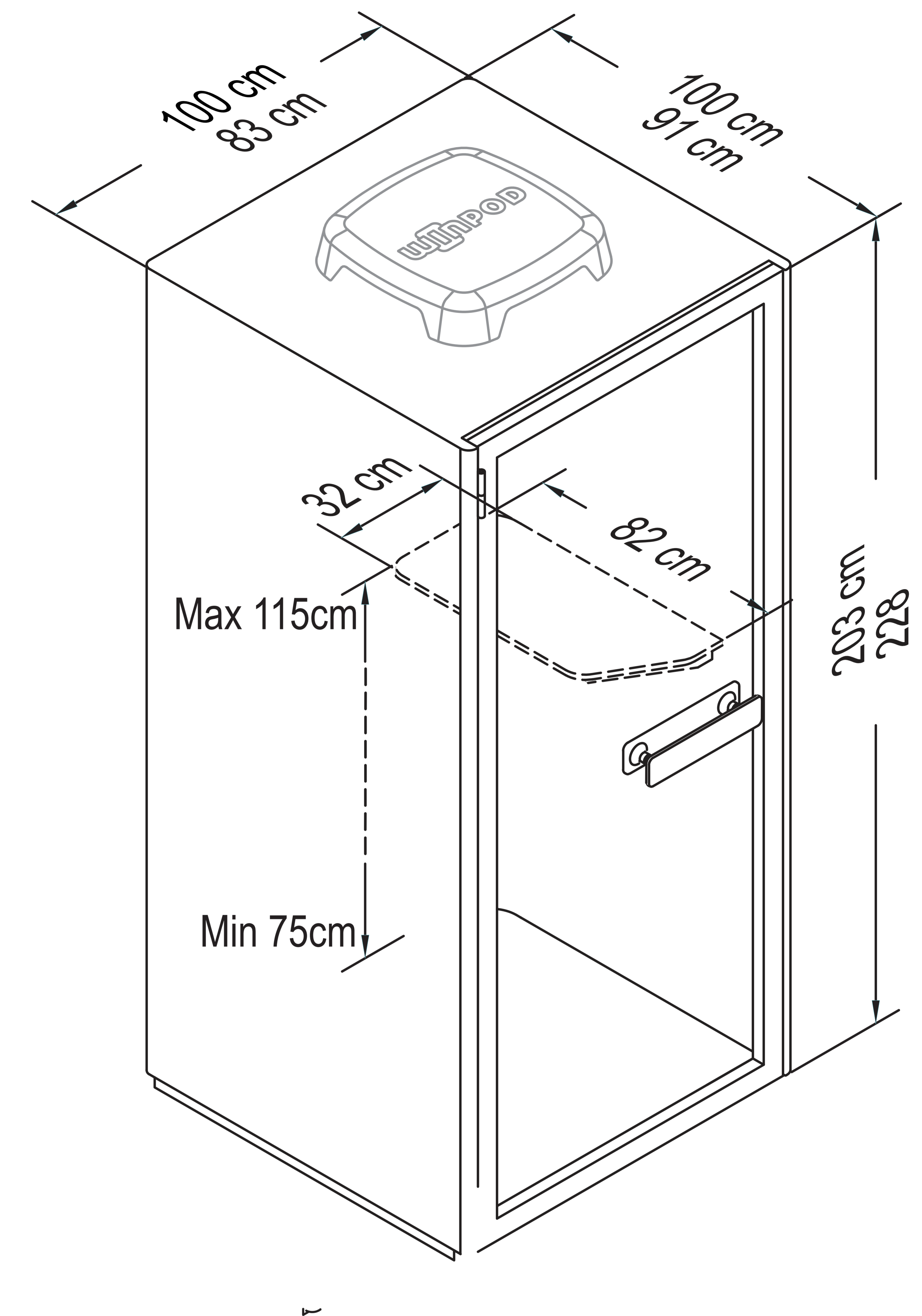

**Table Material:** Melamine Chip Board With Black Edging

**Colour:** Oak & White

**Maximum Load:** 35kg UDL

**Table Dimension:** 820 X 320 X 25mm

### UNIQUE FEATURES

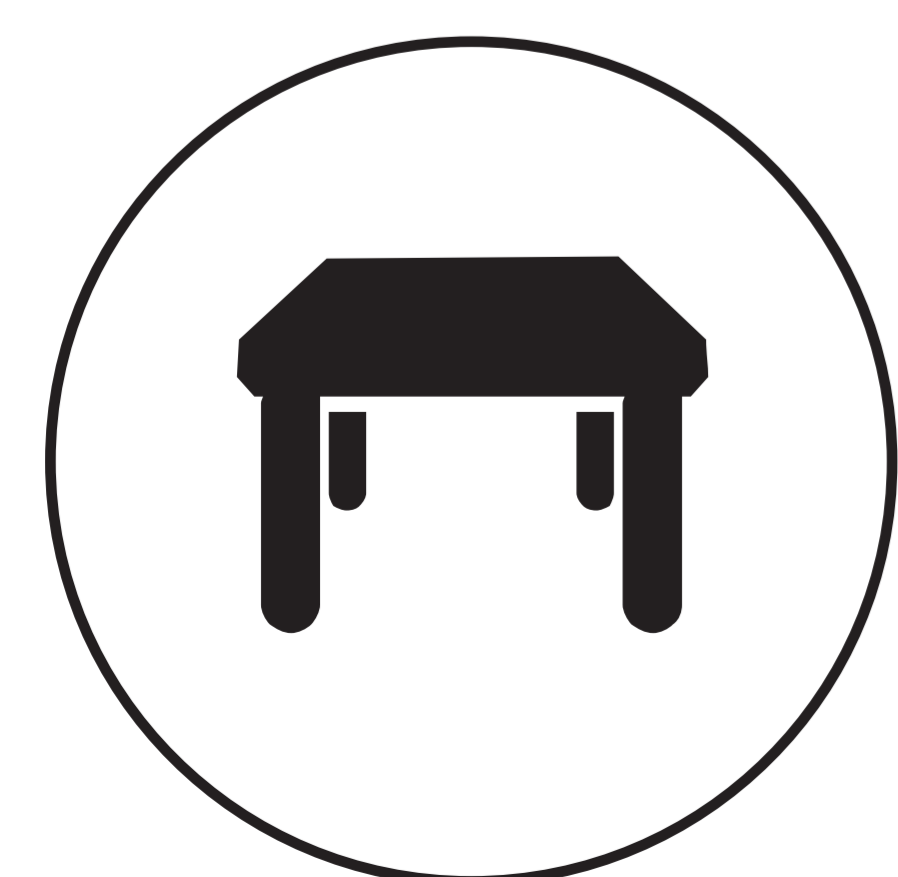

Height Adjustable  
Table



Touch Controller

# WINPOD

BY WINTECH®

REDIFINE YOUR WORKING SPACE

[www.winpod.co.th](http://www.winpod.co.th)

**winpod**  
BY WINTECH



**Multinational Socket**

**65W**

[www.winpod.co.th](http://www.winpod.co.th)

# POD 3.0

*PLUS SERIES*

**Apply to all 3.0 Pod**

**Product : Multinational Socket**

**Watt Output : 65W**

Partner With:



**A. & H. MEYER**

A brand of **legrand**

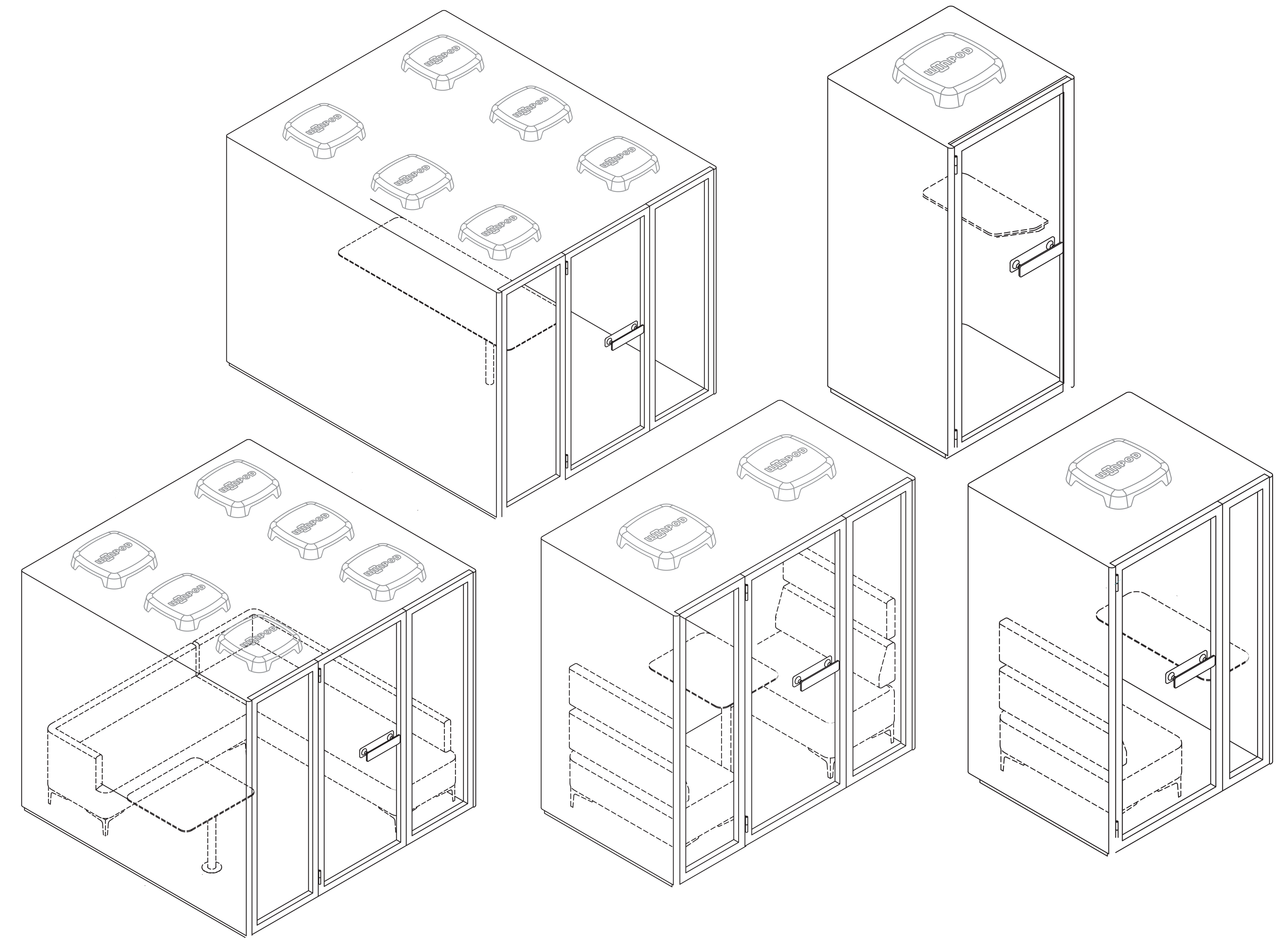

## FURNISHING & FITTINGS

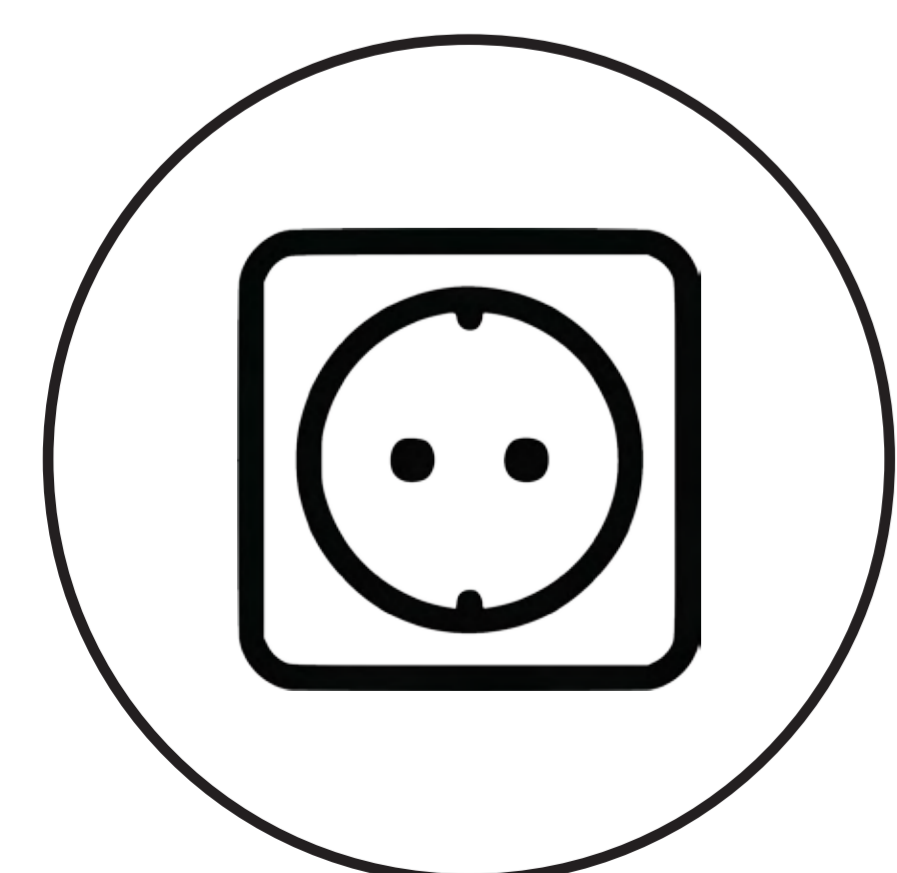

Multinational Socket Design

**winpod**  
BY WINTECH®

REDIFINE YOUR WORKING SPACE

[www.winpod.co.th](http://www.winpod.co.th)

**winpod**  
BY WINTECH

winpod



[www.winpod.co.th](http://www.winpod.co.th)

# Occupancy Light

# POD 3.0

*PLUS SERIES*

Apply to all 3.0 Plus Series

**Product : Light Indicator**

**LED Colour : Red & Green**

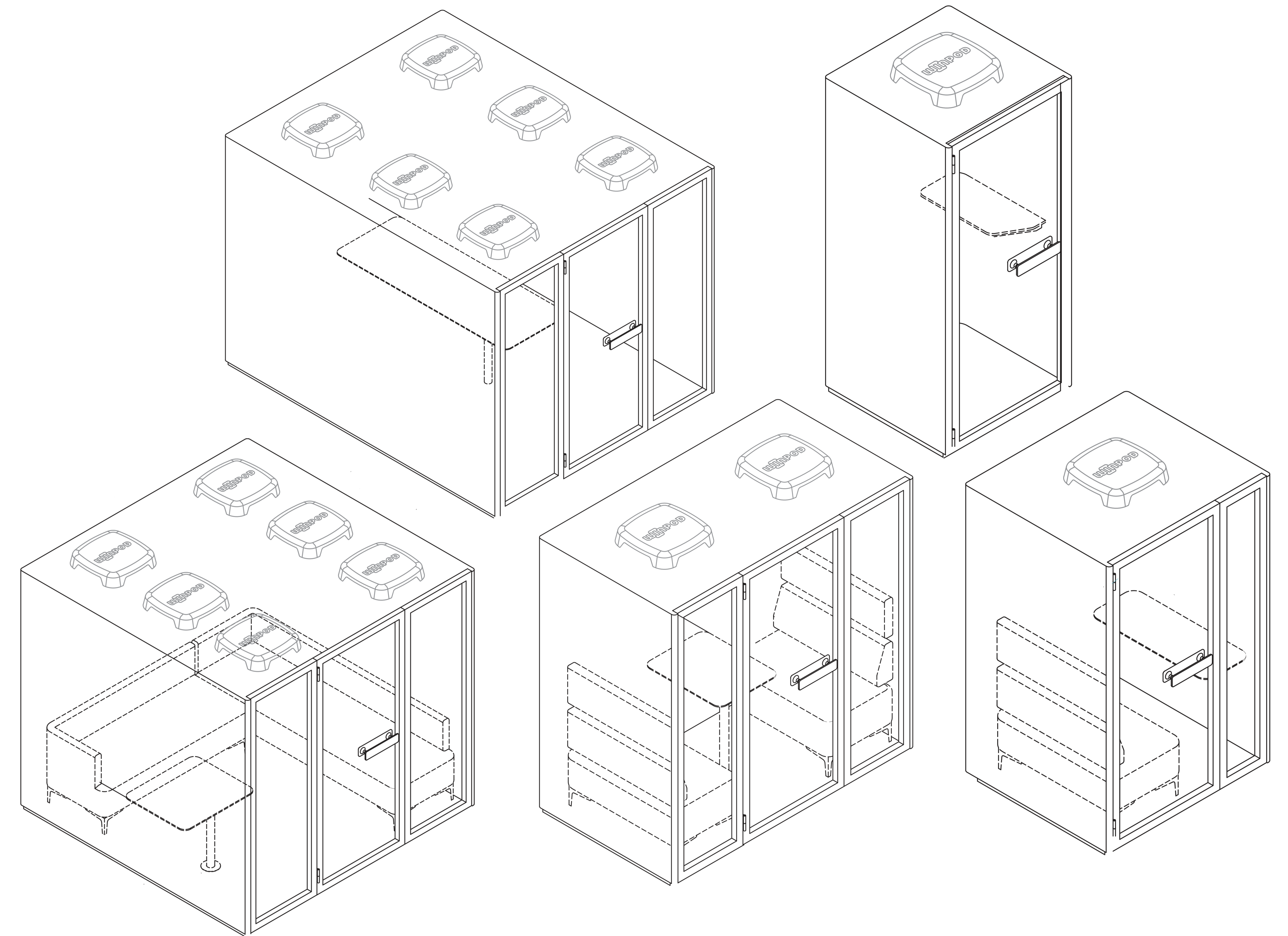

## FURNISHING & FITTINGS



Occupancy Indicator Light

**WINPOD**  
BY WINTECH®

REDIFINE YOUR WORKING SPACE

[www.winpod.co.th](http://www.winpod.co.th)

**winpod**  
BY WINTECH

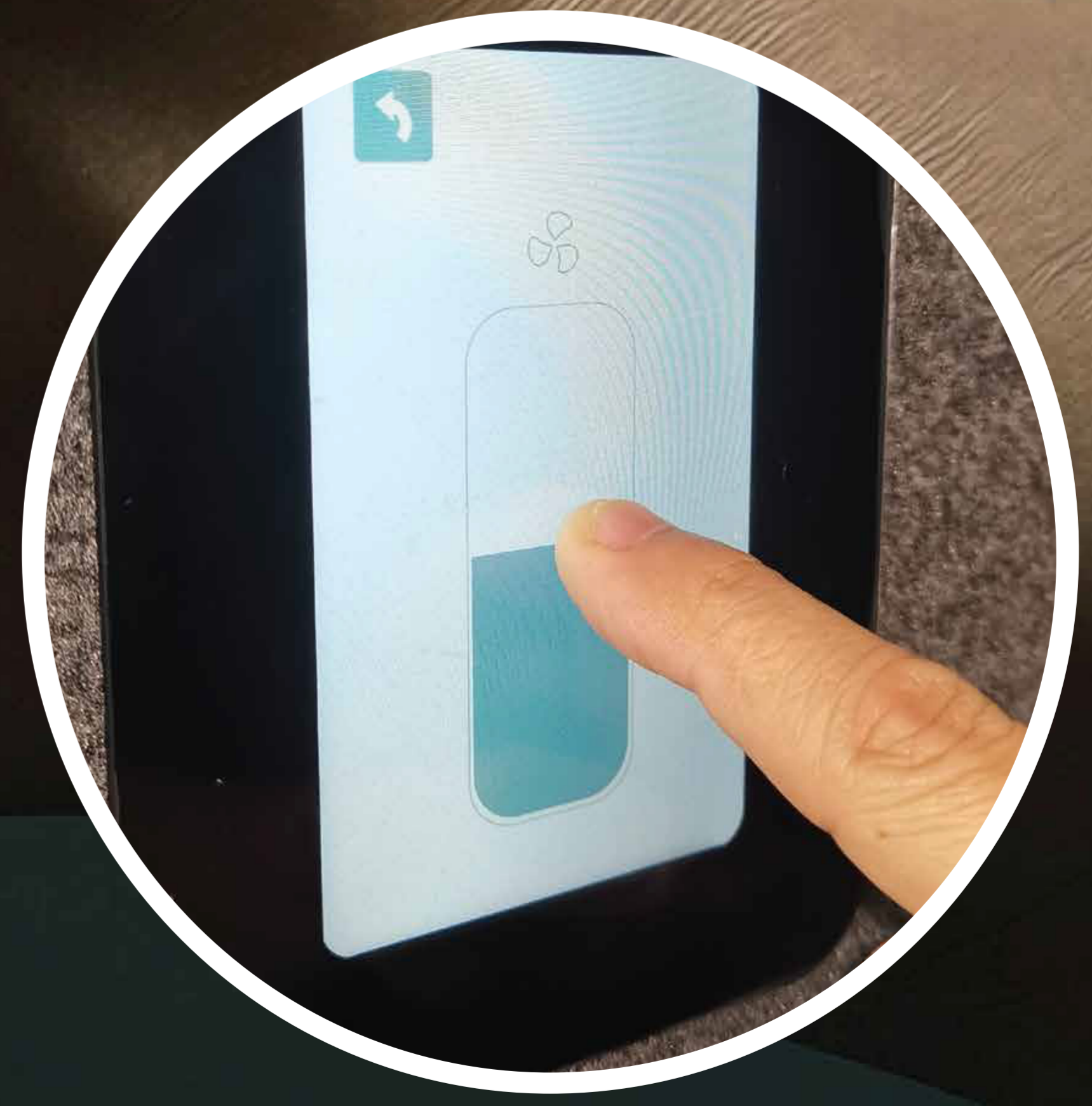

[www.winpod.co.th](http://www.winpod.co.th)

**Interactive** Control Hub

# POD 3.0

*PLUS SERIES*

**Apply to all 3.0 Pod**

**Product :** Interactive Control Hub

**Type :** Touch Digital Panel

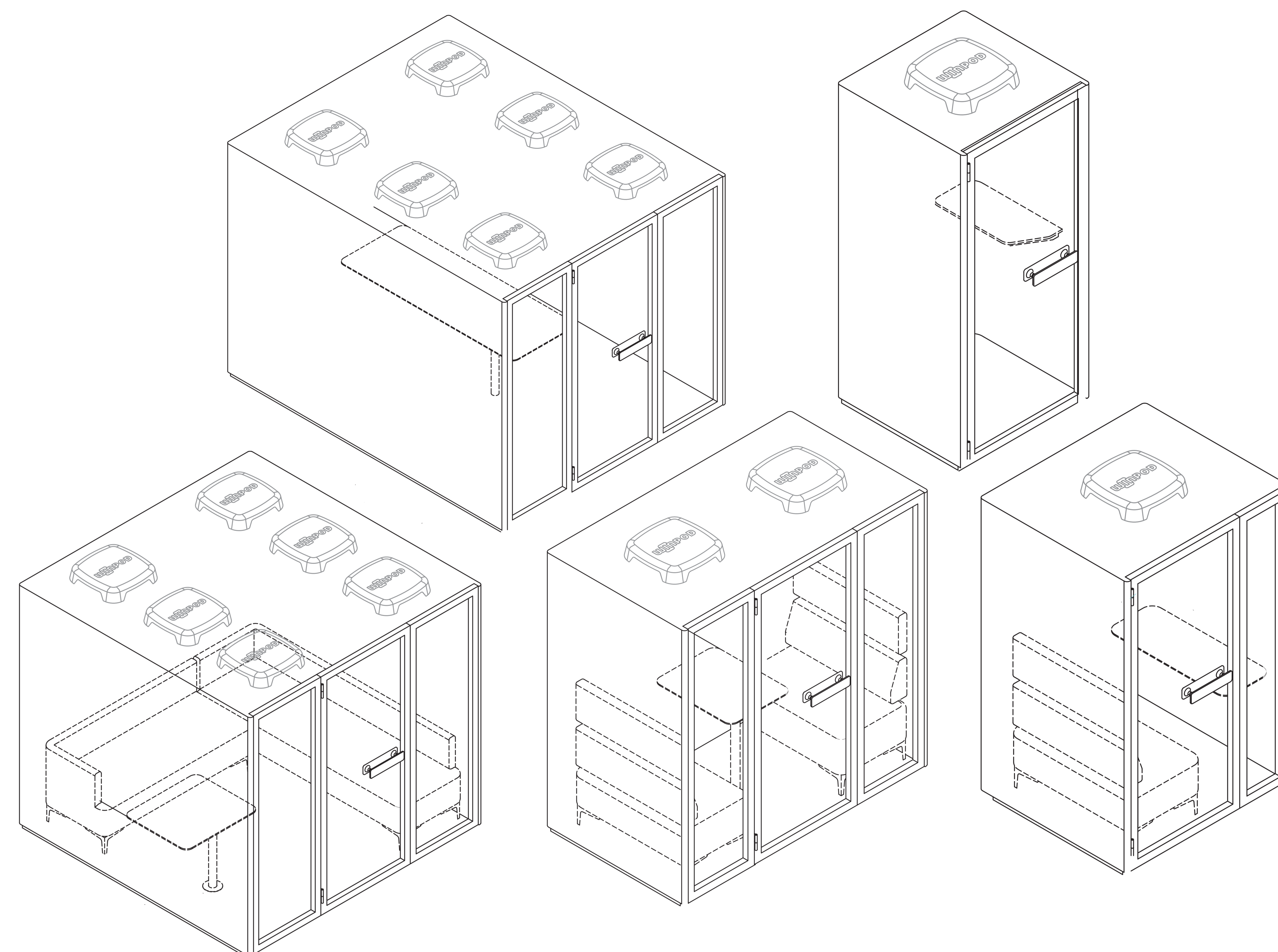

## FURNISHING & FITTINGS

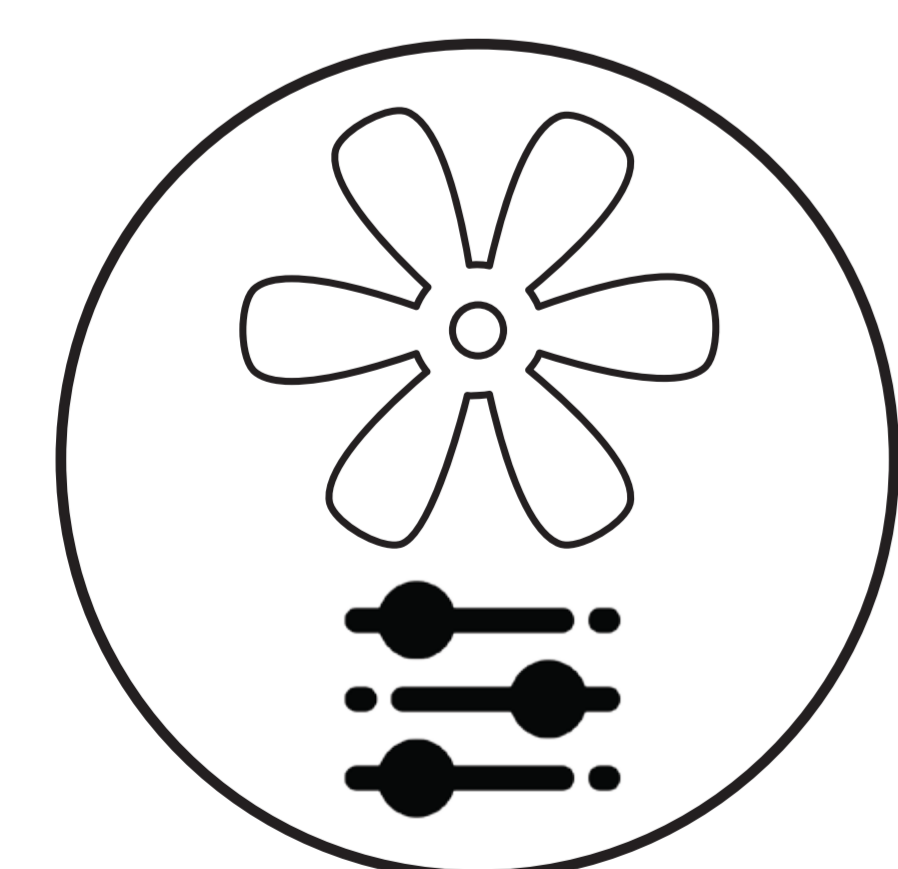

Fan Adjustable



Interactive Control Hub

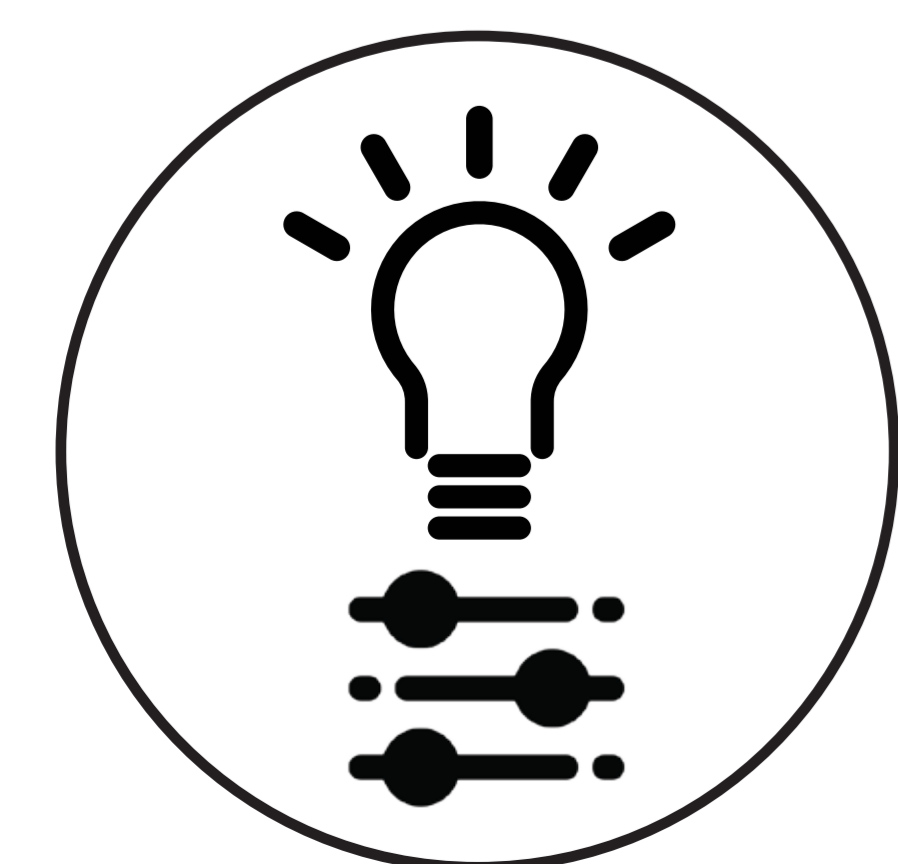

Light Adjustable

**WINPOD**  
BY WINTECH®

REDIFINE YOUR WORKING SPACE

[www.winpod.co.th](http://www.winpod.co.th)

# Smart Advance Booking System

**winpod**  
BY WINTECH®

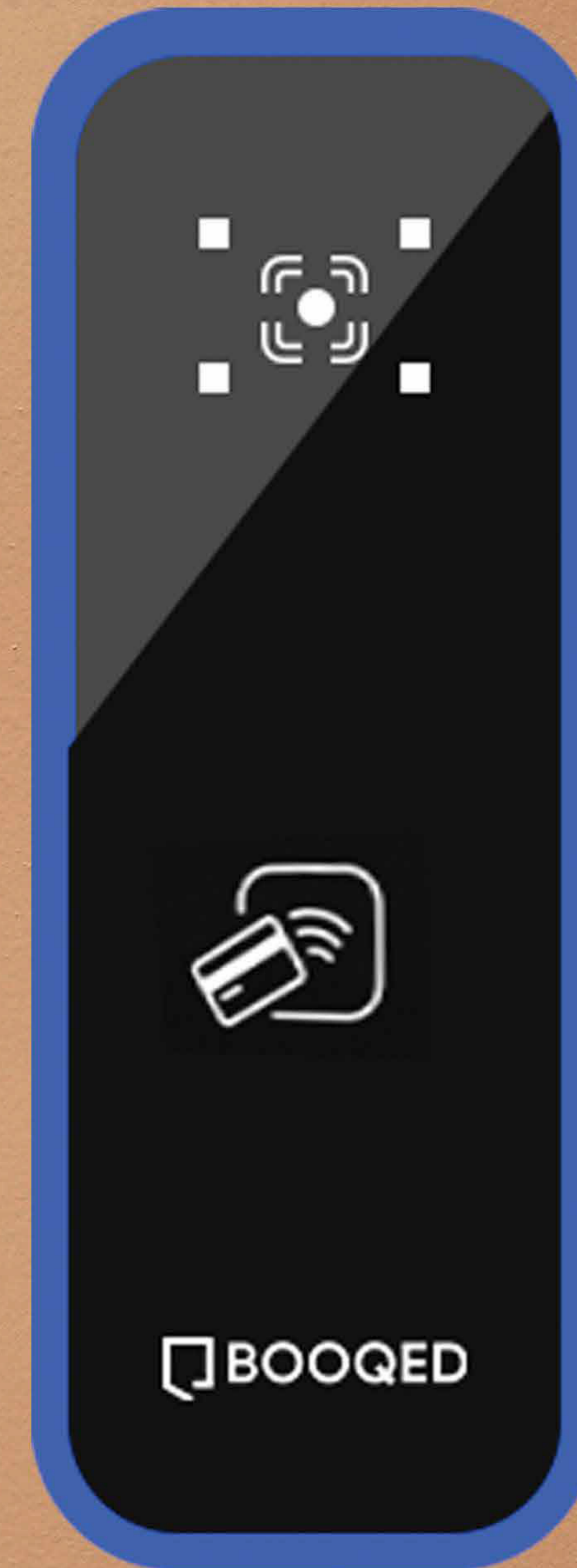
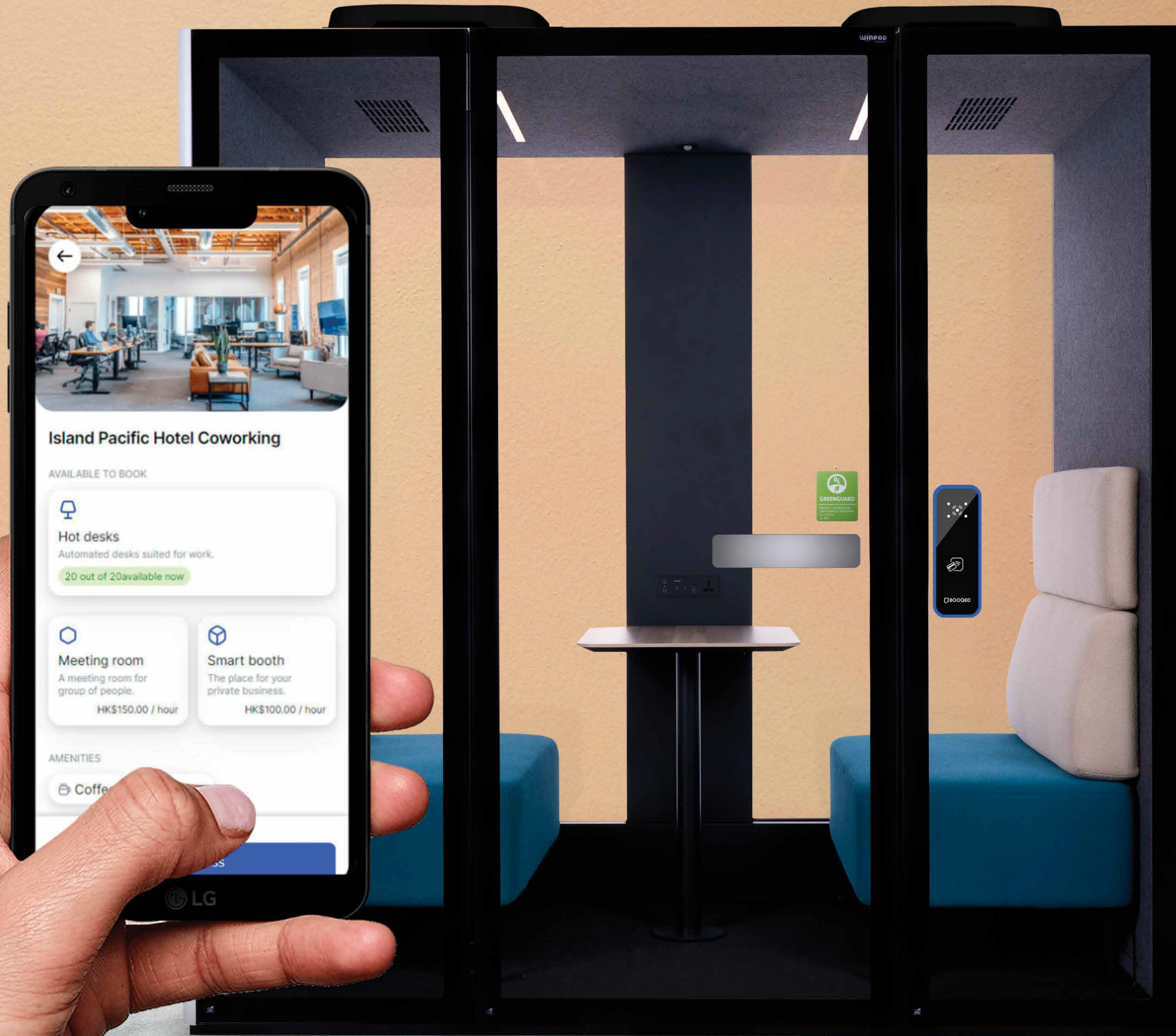

[www.winpod.co.th](http://www.winpod.co.th)

# Hardware & Software

## SMART SERIES

Smart Booths (onsite meeting rooms can be retrofitted)

Access Control (equipped with entry scanner, maglock for door, exit button)

Software – booking platform and admin portal

### Software

- Web app supports real-time bookings and space management for work and meeting spaces
- Admin Portal provides work and meeting space management
- Data analytics on bookings and occupancy (with sensors)

### Smart Access Control

- Fully automated, integrated into booth infrastructure
- Manage use of booths or any meeting room
- Ensures fair usage

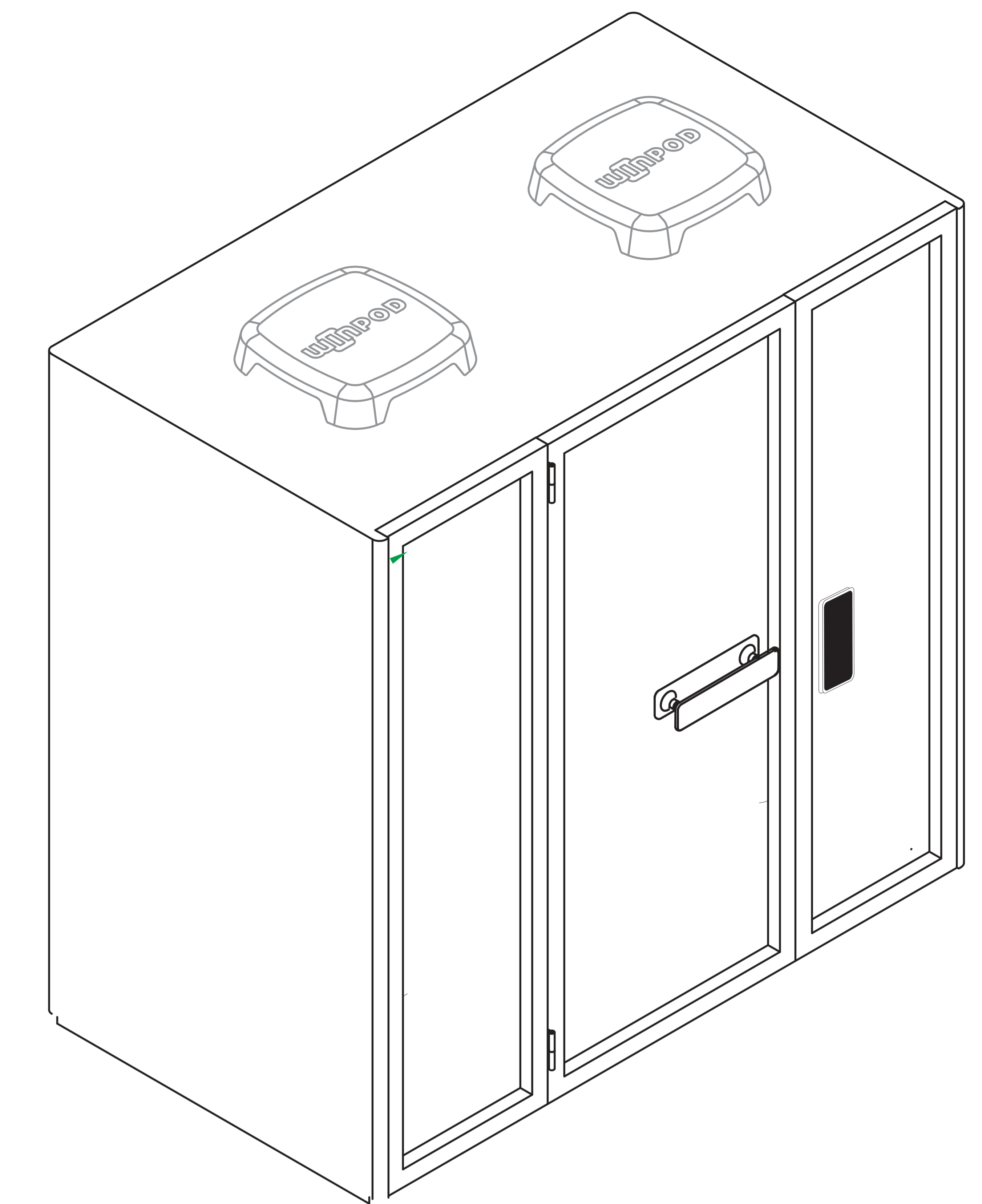

Partner By:  
**KOMSTADT**

## UNIQUE FEATURES

- Quickly create private areas for people to work or meet with booking system for fair usage
- Modular system eliminates need for messy renovations
- Project completion within 1 day ensures minimal disruption to operations
- Smart capabilities provide owners with booking functionality, monetization opportunities, and data analytics capabilities to track utilization for future planning

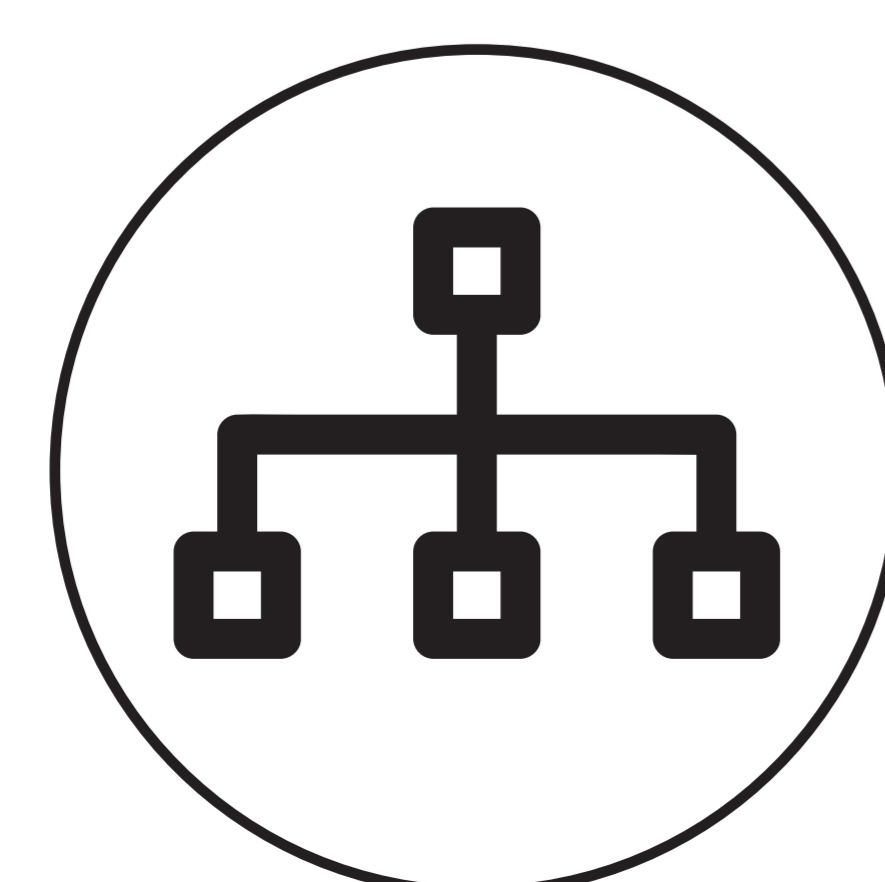

Advance Booking System



RFID Access Card

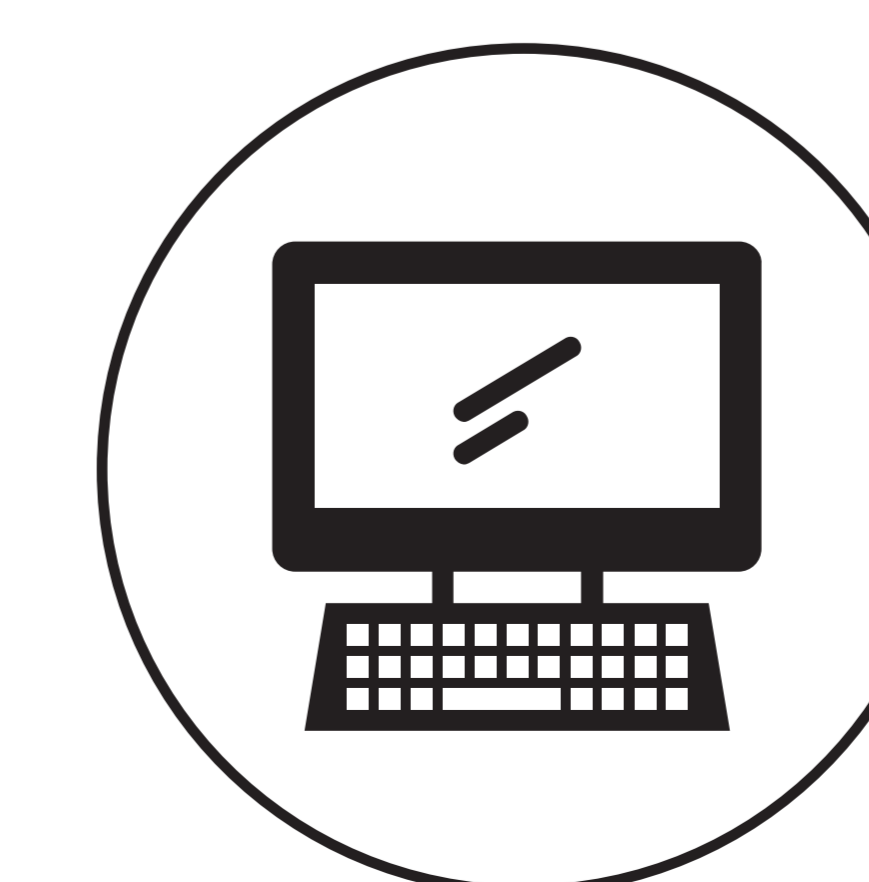

Advance App & Software

# winpod

BY WINTECH

[www.winpod.co.th](http://www.winpod.co.th)

## Design Preference

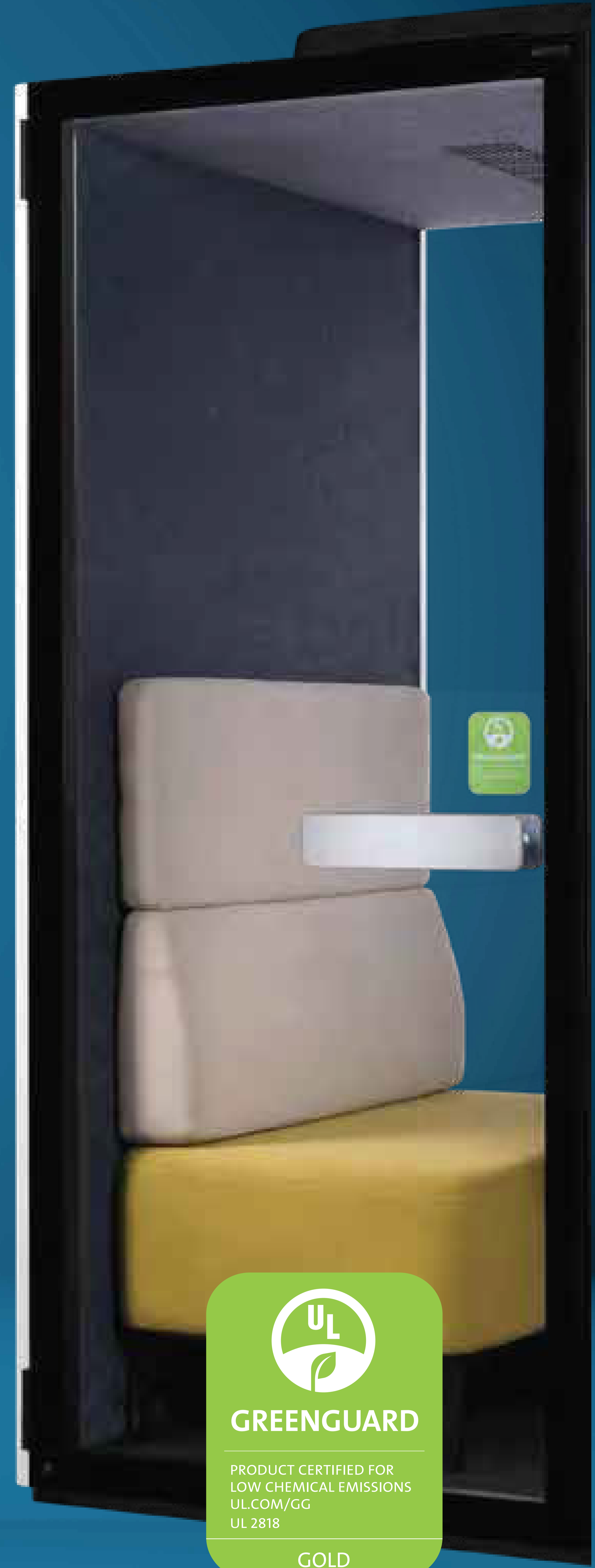

# SOFA

## FABRIC COLOUR SELECTION

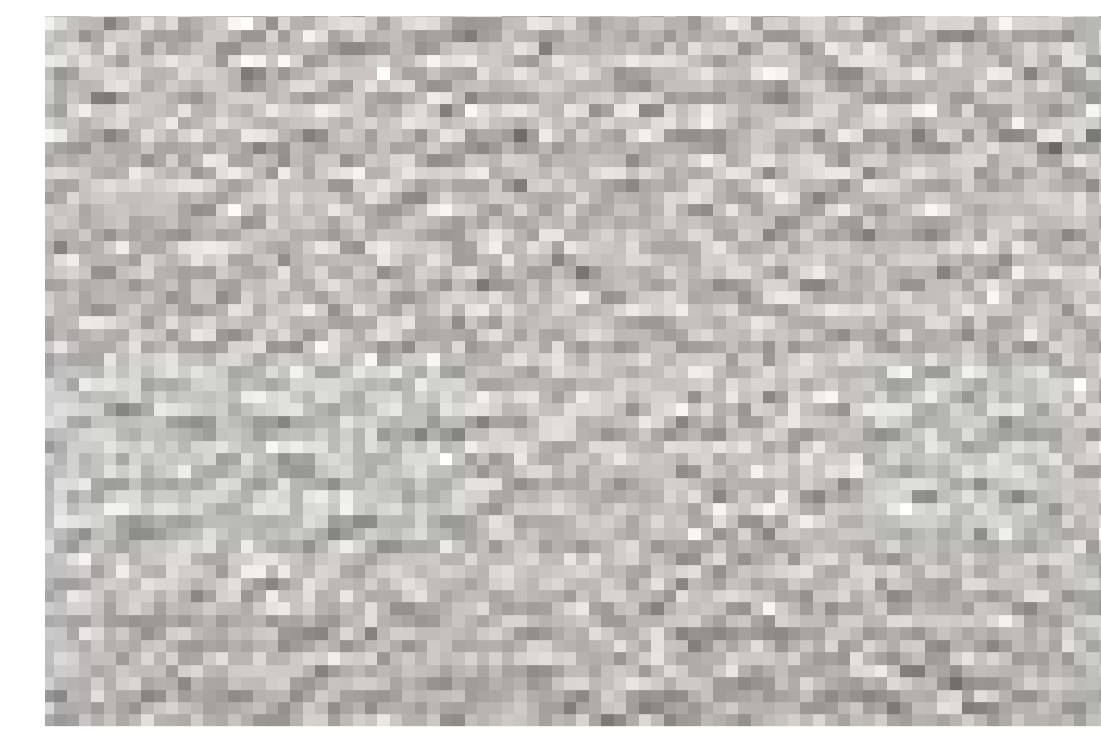

1001  
Oyster White

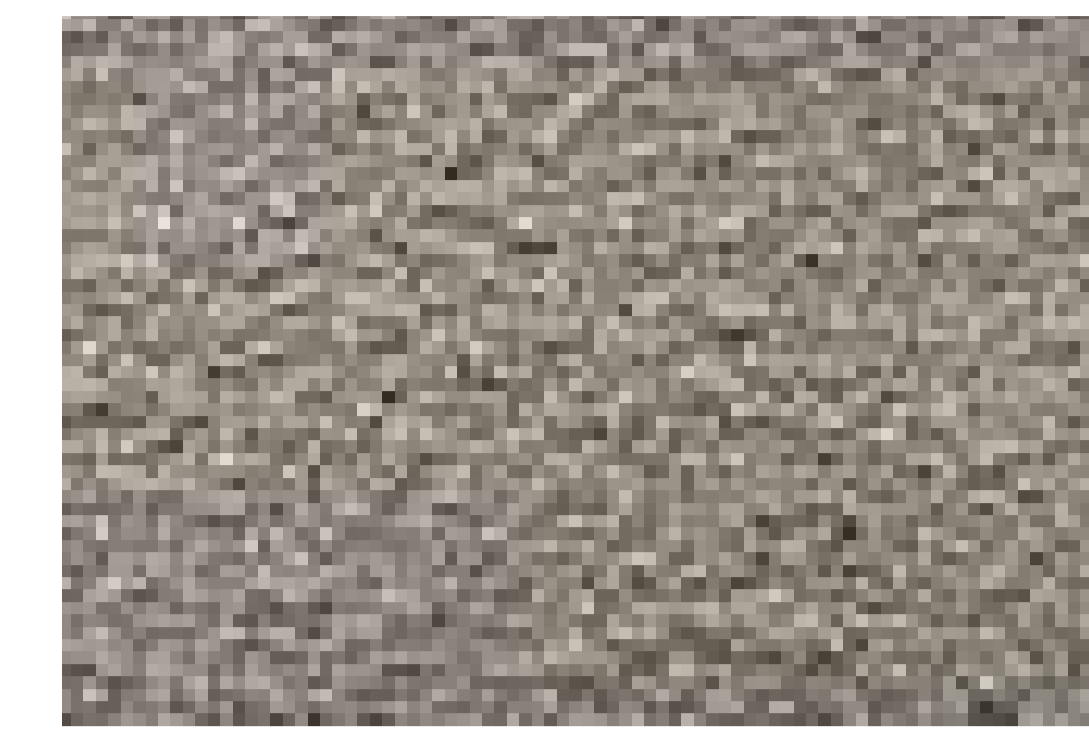

1002  
Beige Grey

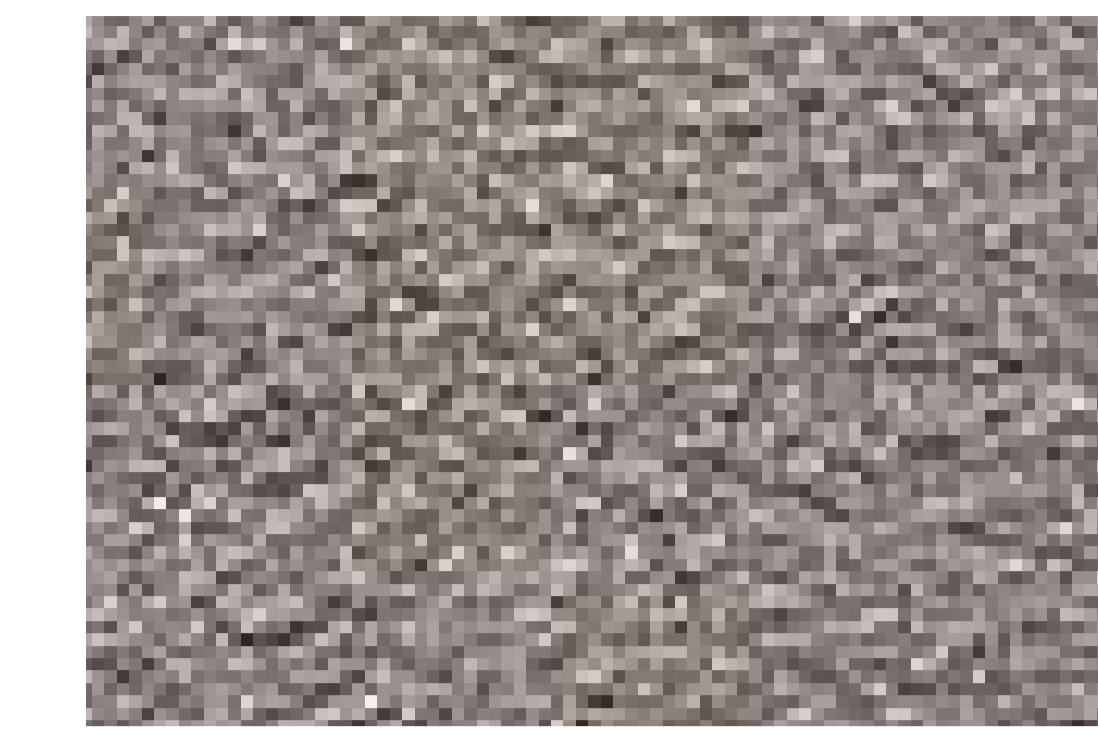

1003  
Brown Grey

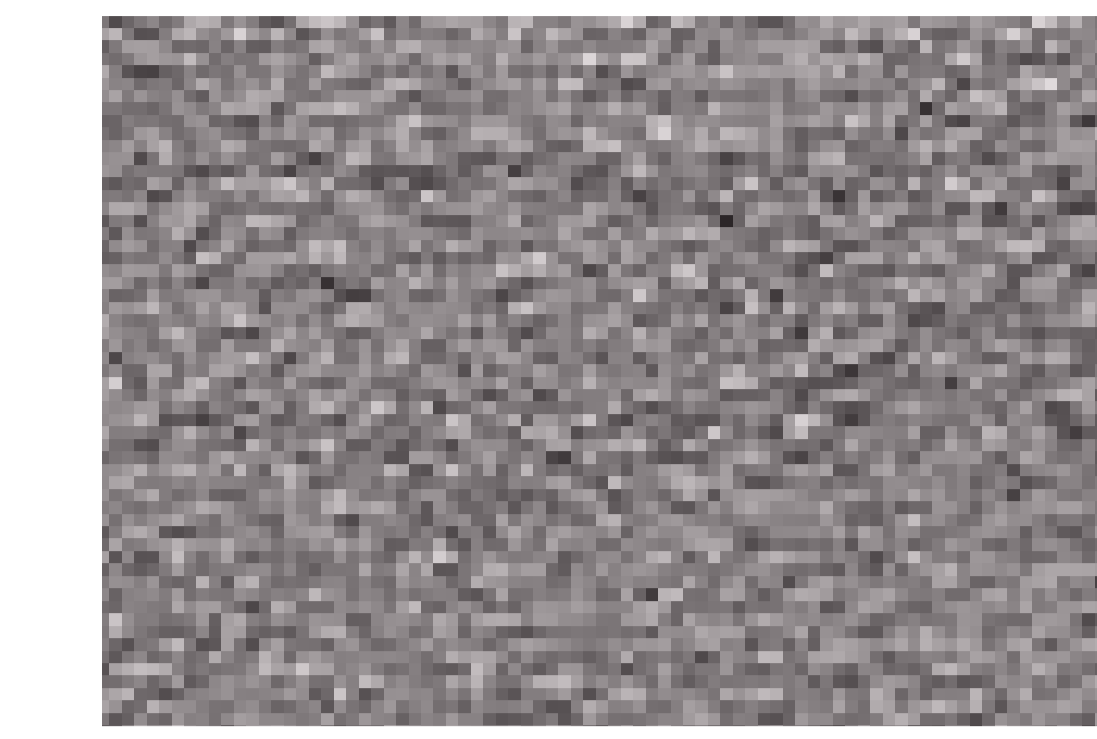

1006  
Dark Grey

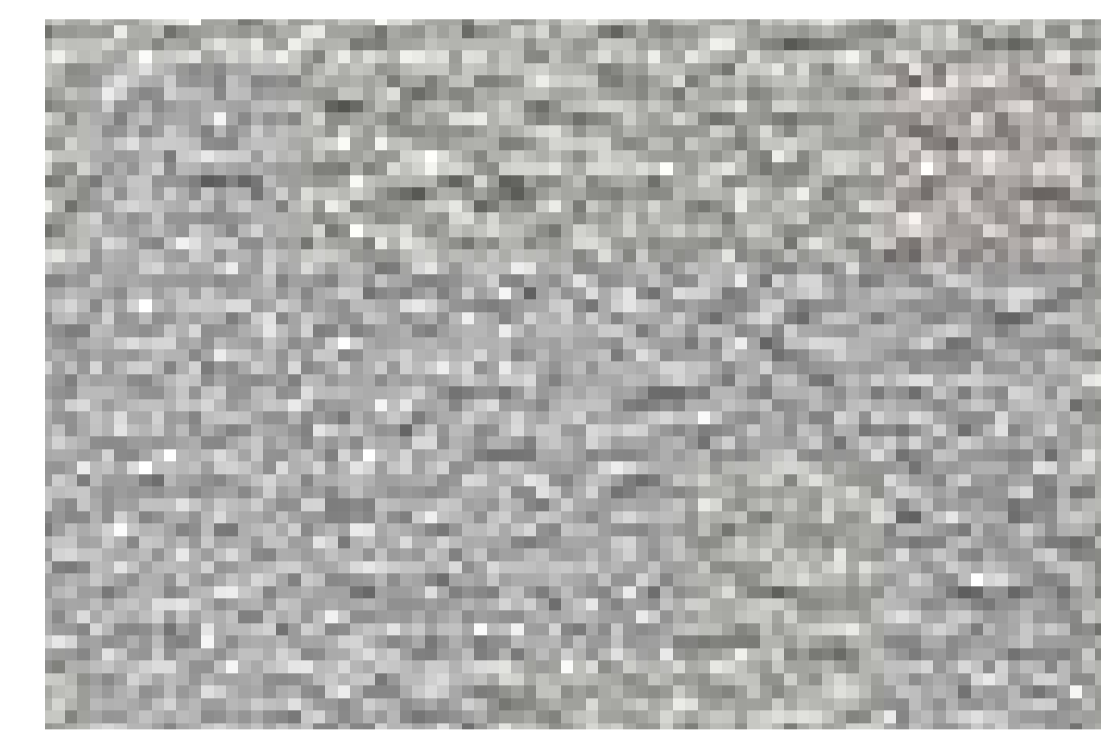

1007  
Grey

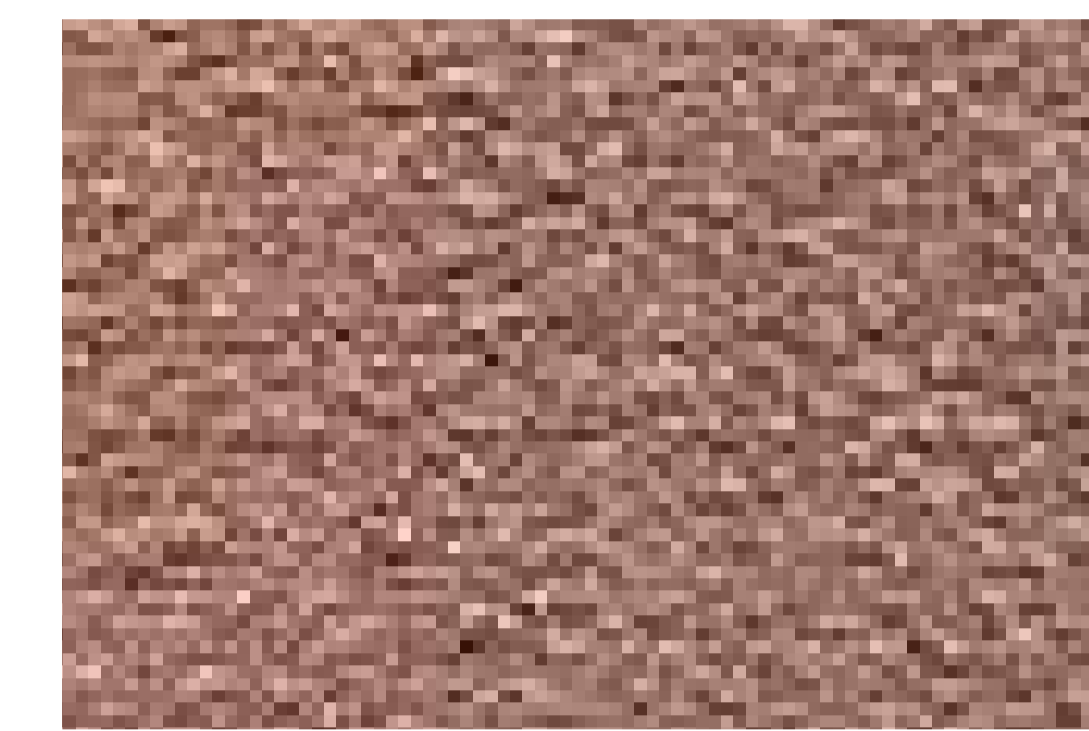

1009  
Brown

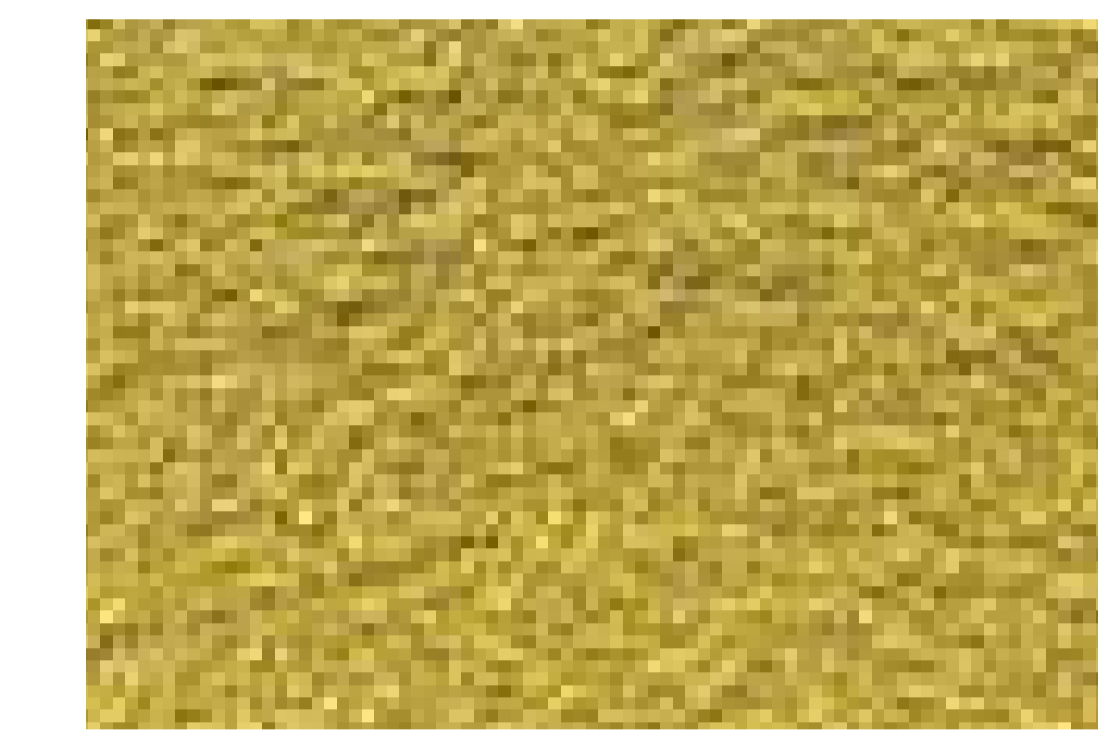

1011  
Yellow

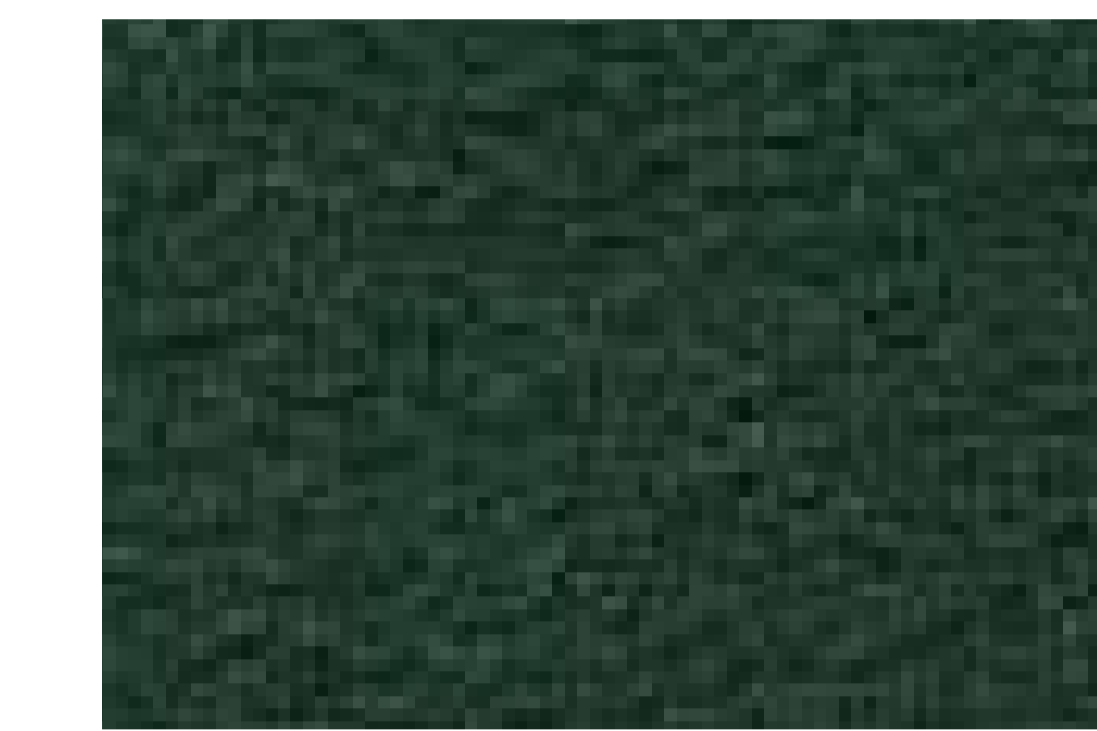

1014  
Dark Green



1015  
Blue



1016  
Dark Blue



1020  
Orange



1021  
Purple



1022  
Peach



1023  
Sky Blue

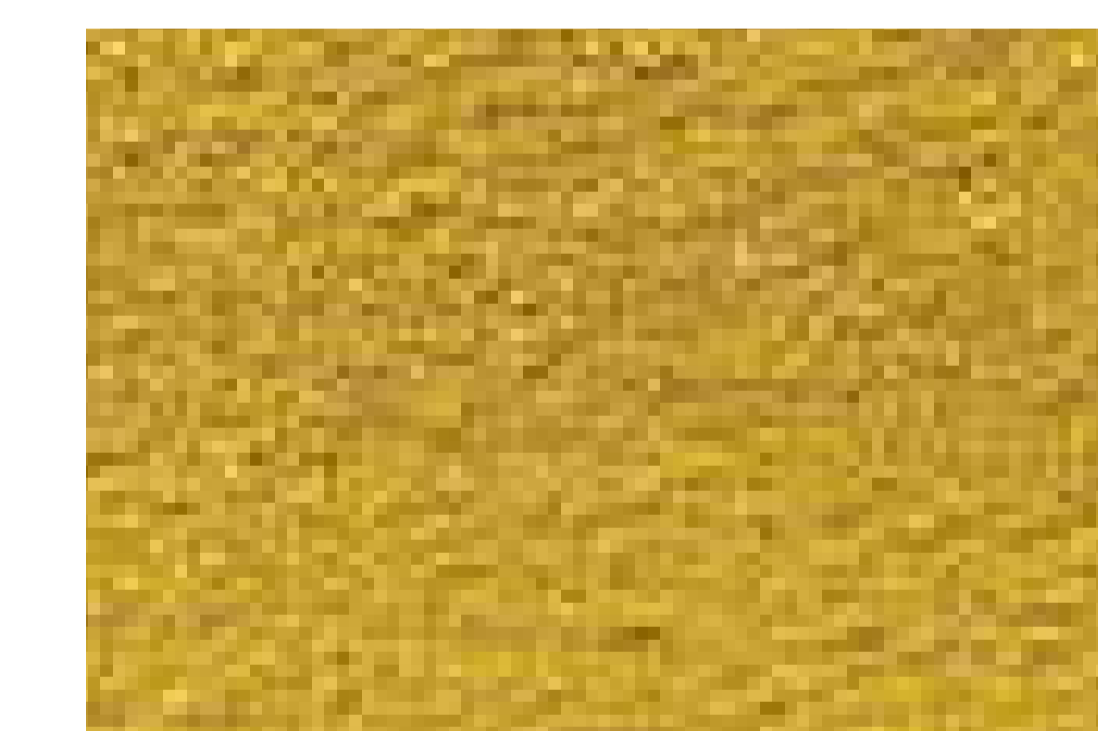

1026  
Lemon Yellow

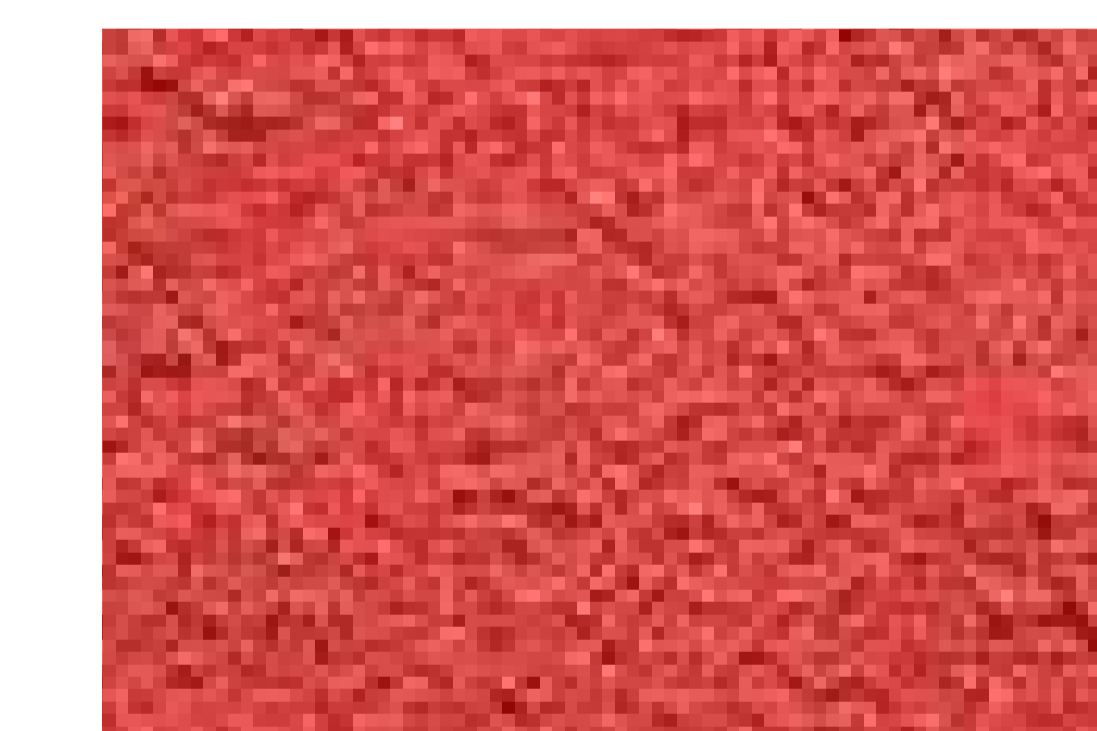

1027  
Brown Red

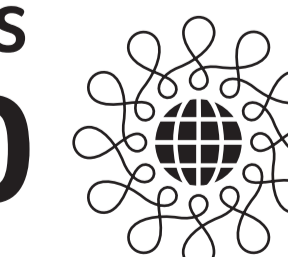

# EXTERIOR

## COLOUR SELECTION



Smoke White



Charcoal Black



Silver



Space Grey



Sky Blue



Lagoon Blue



Rose Pink



Dandelion Yellow

**WINPOD**  
BY WINTECH®  
REDIFINE YOUR WORKING SPACE

# INTERIOR

## ACOUSTIC SHEET COLOUR SELECTION

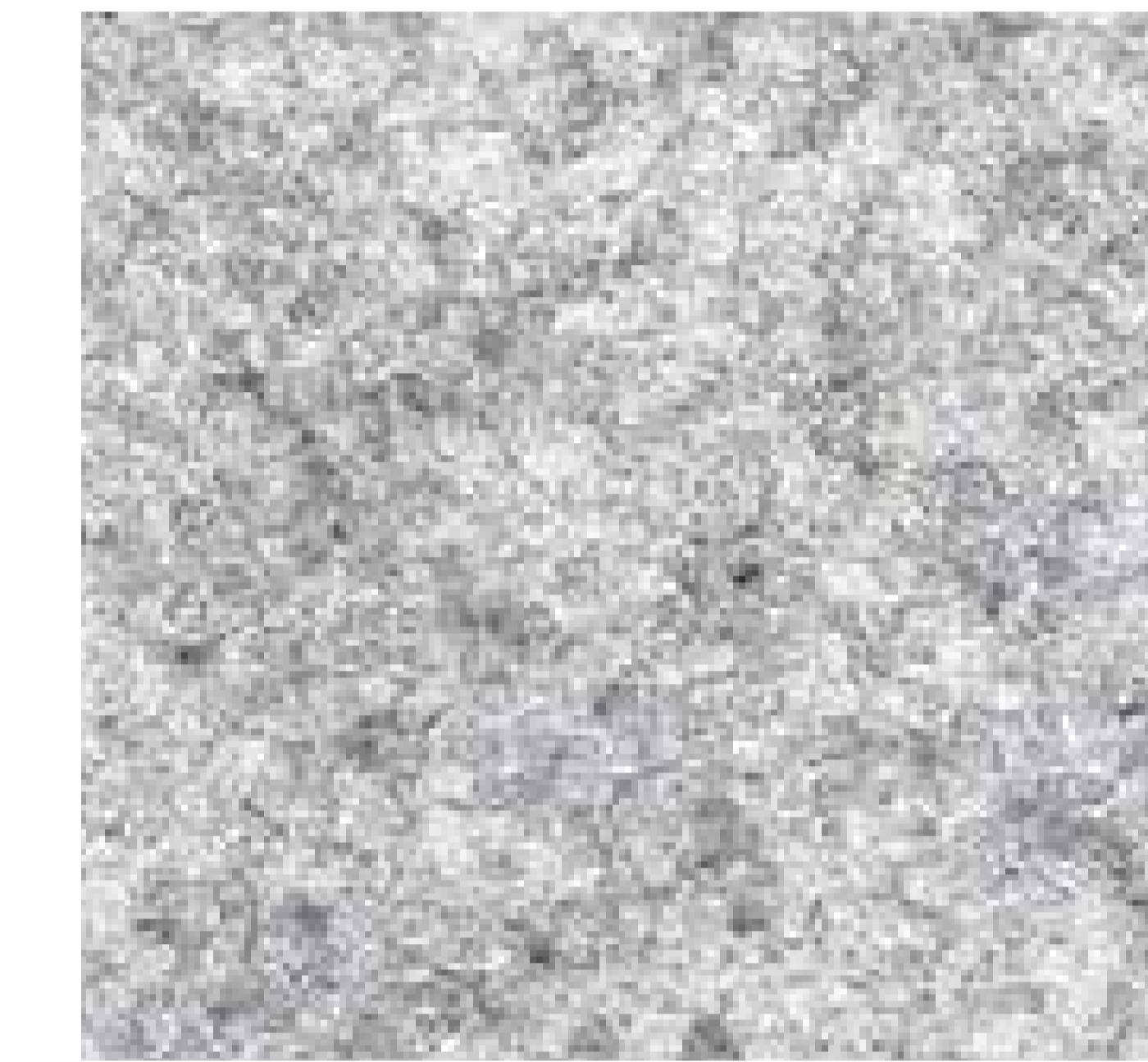

Light Grey



Charcoal Black

## CARPET COLOUR SELECTION



Black



Silver (M POD Only)

OEKO-TEX®  
CONFIDENCE IN TEXTILES  
STANDARD 100



The office features a vibrant open workspace filled with collaborative areas, seamlessly integrated with stylish acoustic pods that provide quiet retreats for focused work.



**WINPOD**  
BY WINTECH®

Redefine Your Workplace

[sales@winpod.co.th](mailto:sales@winpod.co.th)

SCAN HERE



[www.winpod.co.th](http://www.winpod.co.th)

**WINPOD**  
BY WINTECH®  
REDIFINE YOUR WORKING SPACE